

BD LSRFortessa Cell Analyzer User's Guide

For Research Use Only

bdbiosciences.com
23-11093-00 Rev. A
3/2010



Becton, Dickinson and Company
BD Biosciences
San Jose, CA 95131
Tel 877.232.8995
Fax 800.325.9637
ResearchApplications@bd.com

BD Biosciences
European Customer Support
Tel 32.2.400.98.95
Fax 32.2.401.70.94
help.biosciences@europe.bd.com

Copyrights

© 2010, Becton, Dickinson and Company. All rights reserved. No part of this publication may be reproduced, transmitted, transcribed, stored in retrieval systems, or translated into any language or computer language, in any form or by any means: electronic, mechanical, magnetic, optical, chemical, manual, or otherwise, without prior written permission from BD Biosciences.

The information in this guide is subject to change without notice. BD Biosciences reserves the right to change its products and services at any time to incorporate the latest technological developments. Although this guide has been prepared with every precaution to ensure accuracy, BD Biosciences assumes no liability for any errors or omissions, nor for any damages resulting from the application or use of this information. BD Biosciences welcomes customer input on corrections and suggestions for improvement.

Trademarks

Clorox is a registered trademark of The Clorox Company. SPHERO is a trademark of Spherotech, Inc. Modfit LT is a trademark of Verity Software House, Inc. Microsoft and Windows are registered trademarks of Microsoft Corporation. Texas Red® and Alexa Fluor® are registered trademarks, and Pacific Blue™ is a trademark, of Molecular Probes, Inc. Teflon is a registered trademark of E.I. du Pont de Nemours and Company.

Cy™ is a trademark of Amersham Biosciences Corp. Cy™ dyes are subject to proprietary rights of Amersham Biosciences Corp and Carnegie Mellon University and are made and sold under license from Amersham Biosciences Corp only for research and in vitro diagnostic use. Any other use requires a commercial sublicense from Amersham Biosciences Corp, 800 Centennial Avenue, Piscataway, NJ 08855-1327, USA.

BD, BD Logo and all other trademarks are property of Becton, Dickinson and Company. © 2010 BD

Patents

The BD LSRFortessa™ Cell Analyzer is covered by one or more of the following US Patents and foreign equivalents: 7,129,505; 6,944,338; 6,809,804; 6,683,314; 6,014,904

APC-Cy7: US 5,714,386

BD FACS lysing solution: US 4,654,312; 4,902,613; 5,098,849

Regulatory information

For Research Use Only. Not for use in diagnostic or therapeutic procedures.

Class I (1) Laser Product

FCC information

WARNING: Changes or modifications to this unit not expressly approved by the party responsible for compliance could void the user's authority to operate the equipment.

NOTICE: This equipment has been tested and found to comply with the limits for a Class A digital device, pursuant to Part 15 of the FCC Rules. These limits are designed to provide reasonable protection against harmful interference when the equipment is operated in a commercial environment. This equipment generates, uses, and can radiate radio frequency energy and, if not installed and used in accordance with the instruction manual, may cause harmful interference to radio communications. Operation of this equipment in a residential area is likely to cause harmful interference in which case the user will be required to correct the interference at his or her own expense. Shielded cables must be used with this unit to ensure compliance with the Class A FCC limits. This Class A digital apparatus meets all requirements of the Canadian Interference-Causing Equipment Regulations. Cet appareil numérique de la classe A respecte toutes les exigences du Règlement sur le matériel brouilleur du Canada.

Compliance information

NOTICE: This laboratory equipment has been tested and found to comply with the EMC and the Low Voltage Directives. This includes FCC, Part 15 compliance for a Class A Digital Device.

CAUTION: Any unauthorized modifications to this laboratory equipment may affect the Regulatory Compliance items stated above.

History

Revision	Date	Change made
647247 Rev. A	5/2009	New document
23-11093-00 Rev. A	3/2010	Updated

Contents

Chapter 1: About this guide	1
What this guide covers	2
Conventions used in this guide	3
About the BD LSRFortessa documentation	5
Technical assistance	7
Chapter 2: Introduction	9
Instrument overview	10
Components	11
Fluidics	13
Sheath and waste containers	17
Optics	18
Workstation	21
Chapter 3: Cytometer setup	23
Starting the cytometer and computer	24
Preparing the sheath container	26
Removing air bubbles	28
Preparing the waste container	30
Priming the fluidics	33
About the optical filters and mirrors	34
Changing optical filters and mirrors	36
Custom configurations and baselines	37

Chapter 4: Maintenance	39
Maintenance overview	40
Cleaning the fluidics	41
Shutting down the cytometer	43
Flushing the system	44
Maintaining the waste management system	46
Replacing the waste air filter	49
Changing the sheath filter	50
Changing the Bal seal	52
Changing the sample tube O-ring	54
Chapter 5: Optimizing cytometer settings	57
Cytometer settings workflow	58
Verifying the configuration and user preferences	61
Running a performance check	64
Setting up an experiment	69
Creating application settings	73
Recording compensation controls	76
Calculating compensation	80
Chapter 6: Recording and analyzing data	81
Data recording and analysis workflow	82
Preparing the workspace	83
Recording data	85
Analyzing data	88
Reusing an analysis	94
Chapter 7: Technical overview	97
About fluidics	98
About optics	100
About electronics	111

Chapter 8: Troubleshooting	115
Cytometer troubleshooting	116
Electronics troubleshooting	127
Chapter 9: Detector array configurations	129
Fluorescence spectra	130
About configuration maps	132
About the base configuration	133
Base configuration octagon and trigon maps	138
Special Order configurations	149
Chapter 10: Manual settings	163
About laser delay	164
Optimizing laser delay	165
Adjusting area scaling	168
Chapter 11: Supplies and consumables	175
Ordering information	176
Particles	177
Reagents	178
Equipment	179
Index	181

1

About this guide

This section includes these topics:

- [What this guide covers \(page 2\)](#)
- [Conventions used in this guide \(page 3\)](#)
- [About the BD LSRFortessa documentation \(page 5\)](#)
- [Technical assistance \(page 7\)](#)

What this guide covers

This guide describes the procedures necessary to operate and maintain your BD LSRFortessa™ cell analyzer. Because many cytometer functions are controlled by BD FACSDiva™ software, this guide also contains information about software features required for basic cytometer setup and operation.

This guide assumes you have a working knowledge of basic Microsoft® Windows® operation. If you are not familiar with the Windows operating system, see the documentation provided with your computer.





Conventions used in this guide

About this topic

This topic describes the conventions used throughout this guide.

Safety symbols

These safety symbols are used in this guide and on safety labels to alert you to potential hazards.

Symbol	Meaning
	Caution alert Identifies a hazard or unsafe practice that could result in data loss, material damage, minor injury, severe injury, or death
	Biological hazard
	Electrical hazard
	Laser hazard
	Hot surface; High temperatures; Burn hazard

Text and keyboard conventions

Convention	Use
Notes	A note describes important features or instructions.
Bold	Bold is used to indicate software elements such as dialogs, fields, and buttons.
<i>Italics</i>	Italics are used to highlight book titles. Italics are also used in describing software to indicate specific text typed into a window or dialog.
>	The arrow is used to indicate menu selection paths. For example, “ Select File > Print ” means to select the Print option from the File menu.
Ctrl+X	When used with key names, a plus sign (+) means to press two keys simultaneously. For example, Ctrl+P means to hold down the Control key while pressing the <i>p</i> key.

About the BD LSRFortessa documentation

About this topic

This topic describes the documentation available with the BD LSRFortessa flow cytometer.

Publication formats

This guide is provided in PDF format to provide an eco-friendly option. All content is also included in the BD FACSDiva software Help.

Online help

The online help installed with BD FACSDiva software includes all content from this guide and the documents listed below. Access BD LSRFortessa online help from the **Help** menu in BD FACSDiva software.

The online help is compiled from the following documents:

- *BD FACSDiva Software Reference Manual*: Includes instructions or descriptions for installation and setup, workspace components, acquisition controls, analysis tools, and data management. Access this manual from the BD FACSDiva Software **Help** menu (**Help > Literature > Reference Manual**), or by double-clicking the shortcut on the desktop.
- *BD Cytometer Setup and Tracking Application Guide*: Describes how to use the Cytometer Setup and Tracking features in BD FACSDiva software.
- *BD LSRFortessa Cell Analyzer Site Preparation Guide*: Contains specifications for:
 - Cytometer weight and size
 - Temperature and other environmental requirements
 - Electrical requirements

- *BD High Throughput Sampler User's Guide*: Describes how to set up and operate the BD™ High Throughput Sampler (HTS) option. It also contains a description of BD FACSDiva software features specific to the HTS.
 - *BD FACSTFlow Supply System User's Guide*: Describes the optional automated sheath and waste fluid control system designed for use with the BD™ LSR II and BD LSRFortessa.
-

Technical assistance

About this topic

This topic describes how to get technical assistance.

Getting assistance from this guide

For technical questions or assistance in solving a problem:

- Read the sections of the documentation specific to the operation you are performing. See [About the BD LSRFortessa documentation \(page 5\)](#) for more information.
 - See [Troubleshooting \(page 115\)](#).
-

Contacting technical support

If additional assistance is required, contact your local BD Biosciences customer support representative or supplier.

When contacting BD Biosciences, have the following information available:

- Product name, part number, and serial number
- Version of BD FACSDiva software you are using
- Any error messages
- Details of recent system performance

For cytometer support from within the US, call 877.232.8995.

For support from within Canada, call 888.259.0187.

Customers outside the US and Canada, contact your local BD representative or distributor.

Need more information fast?

Information about this product is also available in your software's Help system.

You can keep the Help window open while you use the software or print the information directly from the window.

Internet access is not required to use the Help system.

2

Introduction

The following topics are covered in this section:

- [Instrument overview \(page 10\)](#)
- [Components \(page 11\)](#)
- [Fluidics \(page 13\)](#)
- [Sheath and waste containers \(page 17\)](#)
- [Optics \(page 18\)](#)
- [Workstation \(page 21\)](#)

Instrument overview

The BD LSRFortessa is an air-cooled multi-laser benchtop flow cytometer with the ability to acquire parameters for a large number of colors. It uses fixed-alignment lasers that transmit light through a flow cell to configurable octagon and trigon detector arrays. These detectors collect and translate the resulting fluorescence signals into electronic signals. Cytometer electronics convert these signals into digital data.

Components

About this topic This topic describes the instrument's components.

Instrument overview

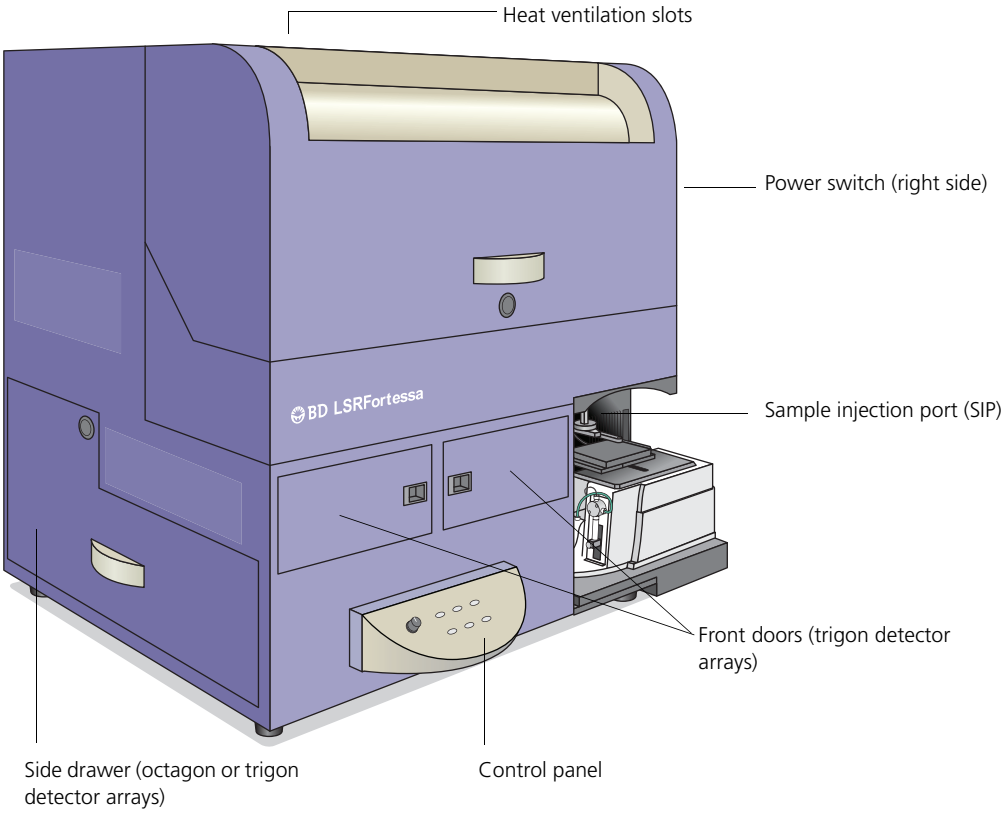

Caution! Do not place any objects on top of the instrument. Blocking the ventilation may cause the instrument to overheat.



Caution: Electrical Hazard! Do not place liquids on top of the instrument. Any spill of liquid into the ventilation openings could cause electrical shock or damage to the instrument.

Power switch

The power switch is located on the right side of the instrument.

Control panel

The control panel contains the following fluidics controls:

- Sample flow rate control buttons
- Fluid control buttons
- Sample fine adjust knob

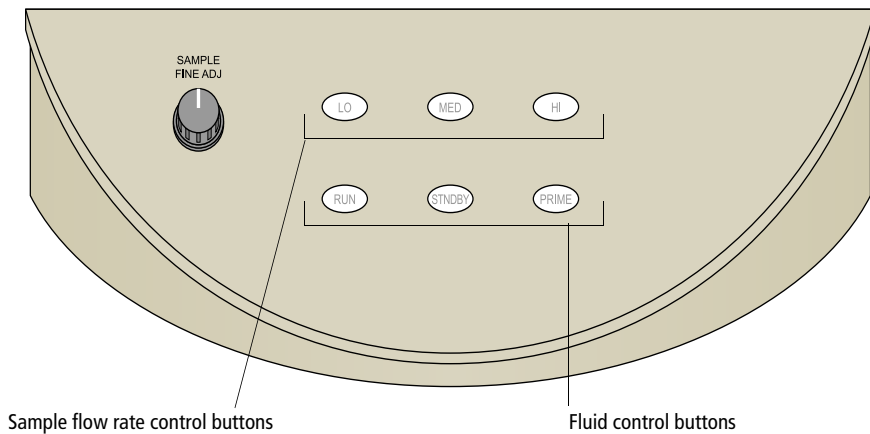

Related topics

- [Fluidics \(page 13\)](#)
 - [Optics \(page 18\)](#)
-

Fluidics

About this topic

This topic describes the fluidics system.

Purpose

The purpose of the fluidics system is to carry the sample out of the sample tube and into the sensing region of the flow cell. Cells are carried in the sample core stream in single file and measured individually.

Sample flow rate control

Three flow rate control buttons (LO, MED, and HI) set the sample flow rate through the flow cell. The SAMPLE FINE ADJ knob allows you to adjust the rate to intermediate levels.

When the SAMPLE FINE ADJ knob is at its midpoint, the sample flow rates at the LO, MED, and HI settings are approximately 12, 35, and 60 $\mu\text{L}/\text{min}$ of sample, respectively. The knob turns five full revolutions in either direction from its midpoint, providing sample flow rates from 0.5–2X the midpoint value. For example, if the LO button is pressed, the knob will give flow rates from approximately 6–24 $\mu\text{L}/\text{min}$.

Fluid control

Three fluid control buttons (RUN, STNDBY, and PRIME) set the cytometer mode.

- **RUN.** Pressurizes the sample tube to transport the sample through the sample injection tube and into the flow cell.

The RUN button is green when the sample tube is on and the support arm is centered. When the tube support arm is moved left or right to remove a sample tube, the cytometer switches to an automatic standby status to conserve sheath fluid, and the RUN button changes to orange.

- **STNDBY (standby).** Stops fluid flow to conserve sheath fluid.

When you leave the cytometer for more than a few minutes, place a tube containing 1 mL of deionized (DI) water on the sample injection port (SIP) and press STNDBY.

- **PRIME.** Prepares the fluidics system by draining and filling the flow cell with sheath fluid.

The fluid flow initially stops and pressure is reversed to force fluid out of the flow cell and into the waste container. After a preset time, the flow cell fills with sheath fluid at a controlled rate to prevent bubble formation or entrapment. At completion, the cytometer switches to standby mode.

Sample injection port

The SIP is where the sample tube is installed. The SIP includes the sample injection tube and the tube support arm. Samples are introduced through a stainless steel injection tube equipped with an outer droplet containment sleeve. The sleeve works in conjunction with a vacuum pump to eliminate droplet formation of sheath fluid as it backflushes from the sample injection tube.

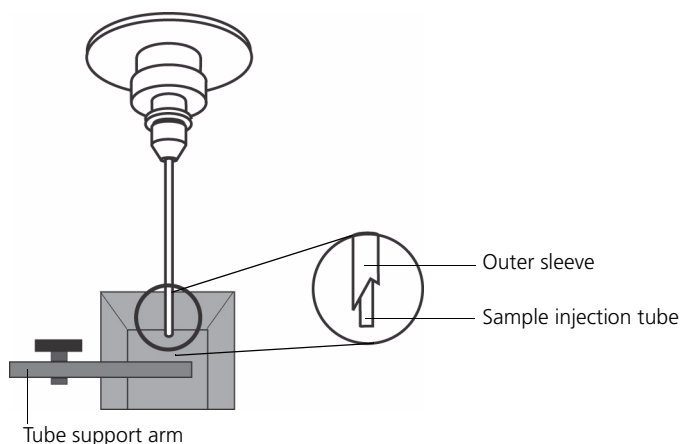

- **Sample injection tube.** Stainless steel tube that carries sample from the sample tube to the flow cell. This tube is covered with an outer sleeve that serves as part of the droplet containment system.
- **Tube support arm.** Arm that supports the sample tube and activates the droplet containment system vacuum. The vacuum is on when the arm is positioned to the side and off when the arm is centered.

Note: If a sample tube is left on the SIP with the tube support arm to the side (vacuum on), the sample will be aspirated into the waste container.

Cautions when using the HTS option

Caution: Biohazard! When using the BD LSRFortessa cytometer with the BD High Throughput Sampler (HTS), ensure that the HTS is completely pushed into the operating position before removing the DCM (droplet containment module) sleeve or disconnecting the sample coupler from the SIP. This is to avoid accidental leakage of potentially biohazardous liquids directly onto the instrument. With the HTS in the proper location, the containment dish with padding is directly below the SIP.



Caution! If you are using the HTS option, always slide the HTS mount slowly to prevent sample cross-contamination when the wells are full. Never move the HTS when it is in operation.



Caution! Do not lean on or put any weight on the HTS as it could damage the instrument.

Droplet containment module

The DCM prevents sheath fluid from dripping from the SIP and provides biohazard protection.

When no sample tube is installed on the SIP, sheath fluid backflushes through the sample injection tube. This backflush helps prevent carryover of cells between samples. The DCM vacuum is activated when the sample tube is removed and the tube support arm is moved to the side. Sheath fluid is aspirated as it backflushes the sample injection tube.

Sheath and waste containers

About this topic

This topic describes the sheath and waste containers. The sheath and waste containers are outside the cytometer and are positioned on the floor.

Note: If your system is using the BD FACSTFlow™ supply system, please see the documentation provided with your system.

Sheath container

The sheath container has a capacity of 8 L. Sheath fluid is filtered through an in-line, interchangeable filter that prevents small particles from entering the sheath fluid lines.



Caution! Do not fill the sheath tank to its maximum capacity (8 L). When an overfull tank is pressurized, erratic cytometer performance can result.

Waste container

The waste container has a capacity of 10 L. An alarm sounds when the container becomes full.

Related topics

- [Preparing the sheath container \(page 26\)](#)
 - [Preparing the waste container \(page 30\)](#)
-

Optics

About this topic

This topic describes the optical components for the BD LSRFortessa cytometer including:

- Detector arrays
 - Laser options
 - Optical filters
 - Signal detectors
-

Detector arrays

The BD LSRFortessa detector arrays consist of:

- **Octagons.** Array of PMTs and filters that can detect up to eight signals.
- **Trigons.** Array of PMTs and filters that can detect up to three signals.

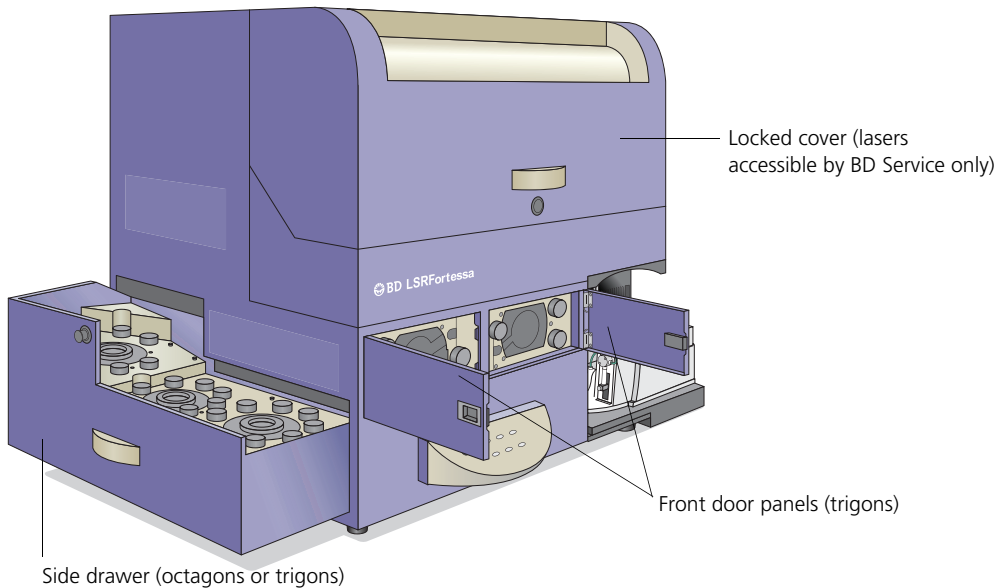

Laser options

The BD LSRFortessa flow cytometer can be configured with up to four lasers listed in the following table. The cytometer can also be upgraded with lasers from this list, or configured with up to five lasers from a variety of wavelengths through our Special Order Research Program.

Lasers	Wavelength (nm)	Power (mW)
Blue	488	50
Red	640	40
Violet	405	50
UV	355	20

Optical filters

Optical filters attenuate light or help direct it to the appropriate detectors. The name and spectral characteristics of each filter appear on its holder.

There are two types of optical filters in the BD LSRFortessa:

- **Longpass dichroic filters (LPs).** Transmit wavelengths that are longer than the specified value and reflect all light below the specified wavelength.
- **Bandpass filters (BPs).** Pass a narrow spectral band of light.

When dichroic filters are used as steering optics to direct different color light signals to different detectors, they are called dichroic mirrors. LP dichroic mirrors transmit longer wavelengths to one detector while reflecting shorter wavelengths to a different detector.

The BD LSRFortessa cytometer octagon and trigon detector arrays use dichroic longpass mirrors on their inner rings, and bandpass filters on their outer rings. You can customize the arrays with other wavelengths of filters and mirrors.

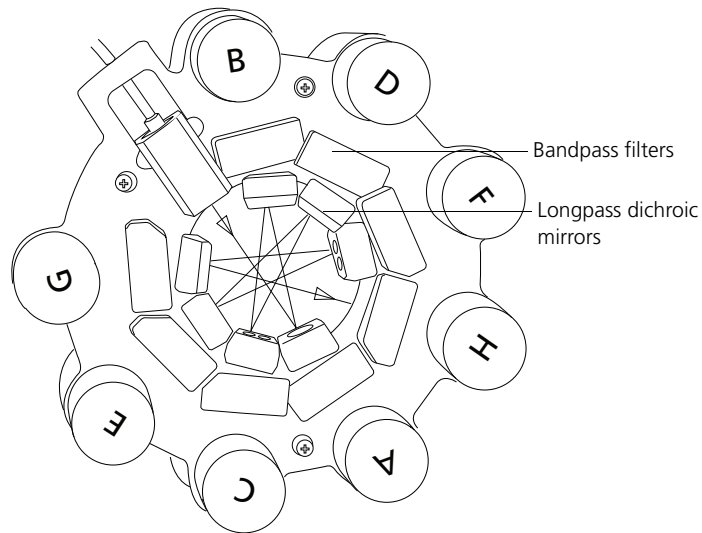

Signal detectors

Light signals are generated as particles pass through the laser beam in a fluid stream. When these optical signals reach a detector, electrical pulses are created that are then processed by the electronics system.

There are two types of signal detectors in the BD LSRFortessa flow cytometer:

- **Photomultiplier tubes (PMTs).** Used to detect the weaker signals generated by side scatter and all fluorescence channels. These signals are amplified by applying a voltage to the PMTs.
- **Photodiodes.** Less sensitive to light signals than the PMTs. A photodiode is used to detect the stronger forward scatter (FSC) signal. However, an optional PMT

for detecting FSC is available through the BD Special Order Research Program.

Related topics

- [Optical filter theory \(page 103\)](#)
 - [About the base configuration \(page 133\)](#)
 - [Special Order configurations \(page 149\)](#)
-

Workstation

About this topic

This topic describes the components of the BD LSRFortessa workstation.

Workstation components

Acquisition, analysis, and most instrument functions are controlled by the BD LSRFortessa workstation. It includes a PC, one or two monitors, and a printer.

Your workstation is equipped with the following:

- Microsoft Windows operating system
 - BD FACSDiva software version 6.2 or later for data acquisition and analysis
 - Software documentation including an online help system
-

Related topics

- [About the BD LSRFortessa documentation \(page 5\)](#)
-

Need more information fast?

Information about this product is also available in your software's Help system.

You can keep the Help window open while you use the software or print the information directly from the window.

Internet access is not required to use the Help system.

3

Cytometer setup

This section includes the following topics:

- [Starting the cytometer and computer \(page 24\)](#)
- [Preparing the sheath container \(page 26\)](#)
- [Removing air bubbles \(page 28\)](#)
- [Preparing the waste container \(page 30\)](#)
- [Priming the fluidics \(page 33\)](#)
- [About the optical filters and mirrors \(page 34\)](#)
- [Changing optical filters and mirrors \(page 36\)](#)
- [Custom configurations and baselines \(page 37\)](#)

Starting the cytometer and computer

About this topic

This topic describes how to start the cytometer and turn on the computer.

Procedure

To start the cytometer:

1. Turn on the power to the flow cytometer.

Note: If your system is using the BD FACSTFlow supply system, make sure that the BD FACSTFlow supply system is powered on before the cytometer.

2. Allow 30 minutes for the optical system temperature to stabilize.



Caution! Failure to warm up and stabilize the instrument could affect sample data.

3. Turn on the computer and log in to Windows.

Note: You can turn on the power to the flow cytometer and the workstation in any order.

4. Start BD FACSDiva software by double-clicking the shortcut on the desktop, and log in to the software.

5. Check the **Cytometer** window in BD FACSDiva software to ensure that the cytometer is connected to the workstation.

The cytometer connects automatically. While connecting, the message *Cytometer Connecting* is displayed in the status area of the **Cytometer** window. When connection completes, the message changes to *Cytometer Connected*.

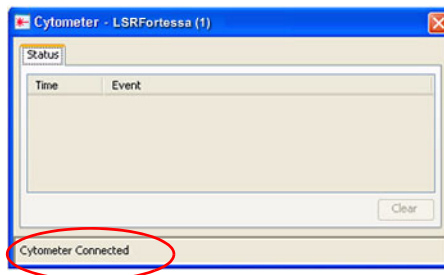

If the message *Cytometer Disconnected* appears, see [Electronics troubleshooting \(page 127\)](#).

Preparing the sheath container

About this topic

This topic describes how to prepare the sheath container.

Note: If your system is using the BD FACSTFlow supply system, please see the documentation provided with your system.

When to check the sheath container

Check the fluid levels in the sheath container every time you use the cytometer. This ensures that you do not run out of sheath fluid during an experiment.

Sheath container components

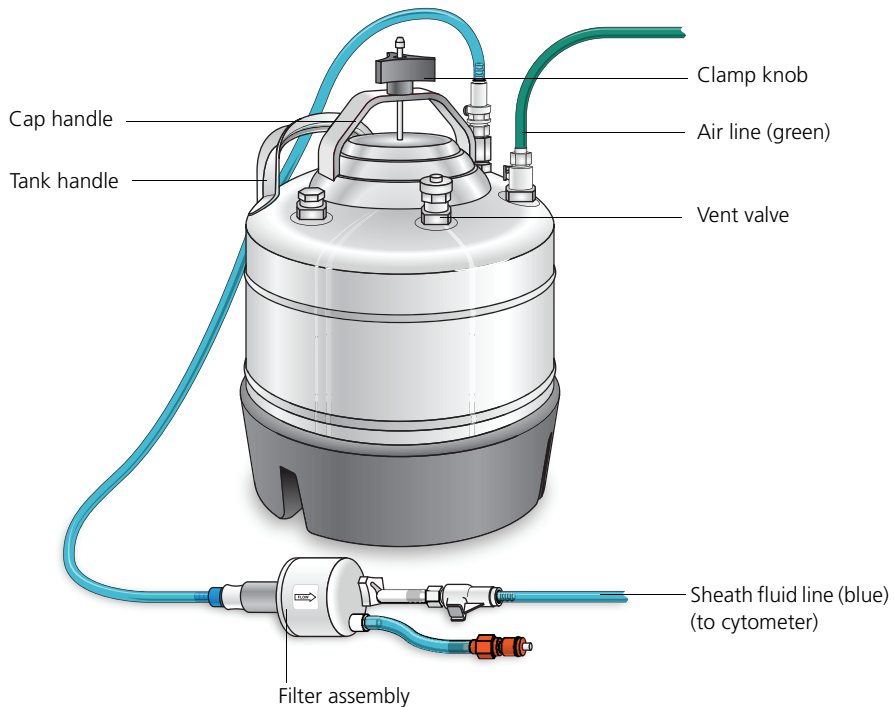

Procedure

To prepare the sheath container:

1. Verify that the flow cytometer is in standby mode.

Press the STNDBY button on the control panel if necessary.
2. Disconnect the air line (green) from the sheath container.
3. Depressurize the sheath container by pulling up on the vent valve.
4. Remove the sheath container lid.

Unscrew the clamp knob and push down to loosen, if necessary. Tilt the cap to the side to remove it from the tank.

5. Add 6 L of sheath fluid, such as BD FACSDiablo solution, to the sheath container.



Caution! Do not fill the sheath tank to its maximum capacity (8 L). When an overfull tank is pressurized, erratic cytometer performance can result.

6. Replace the sheath container lid.
7. Reconnect the air line (green).
8. Make sure the gasket on the inside lip of the sheath lid is seated correctly and has not slipped out of position.

If the gasket is not seated correctly, the tank will not pressurize properly.
9. Close the sheath lid and tighten the clamp knob to finger-tight. Ensure that the sheath fluid line (blue) is not kinked.

Related topics

- [Removing air bubbles \(page 28\)](#)
 - [Changing the sheath filter \(page 50\)](#)
-

Removing air bubbles

About this topic

This topic describes how to remove trapped air bubbles in the sheath filter and the sheath line. Air bubbles can occasionally dislodge and pass through the flow cell, resulting in inaccurate data.

Procedure

To remove air bubbles:

1. Check the sheath filter for trapped air bubbles.

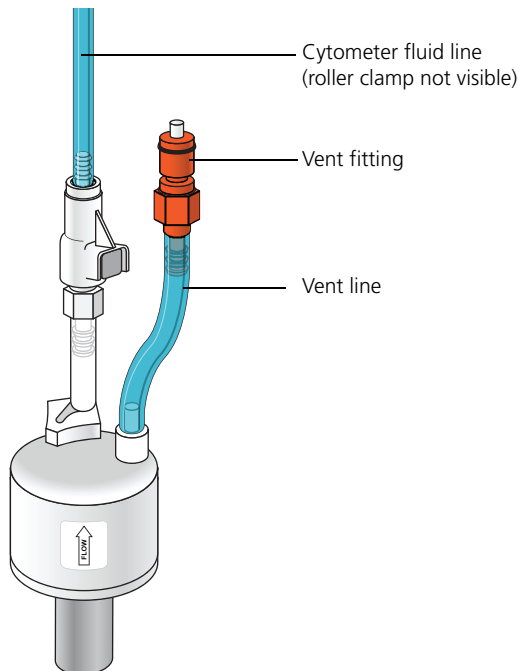

2. If bubbles are visible, gently tap the filter body with your fingers to dislodge the bubbles and force them to the top.

Note: When removing air bubbles, do not vigorously shake, bend, or rattle the sheath filter or you might damage it.

3. Direct the vent line into a beaker and press the small button at the end of the vent fitting against the side of the beaker until a steady stream of fluid empties from the filter.

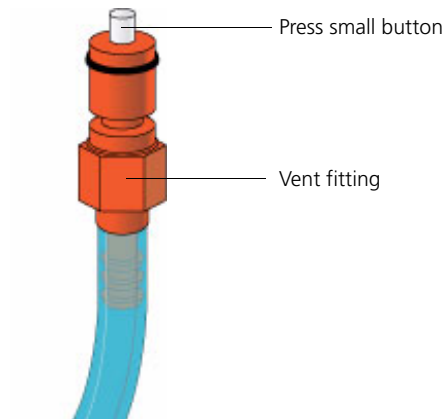

4. Tilt the filter and verify that no trapped air remains in the filter. Repeat steps 3 and 4 until no air is observed in the filter.
 5. Check the sheath line for air bubbles.
 6. Open the roller clamp at the fluidics interconnect (if necessary) to bleed off any air in the line. Collect any excess fluid in a waste container.
 7. Close the roller clamp.
-

Preparing the waste container

About this topic

This topic describes how to prepare the waste container.

Note: If your system is using the BD FACSTFlow supply system, please see the documentation provided with your system.



Caution: Biohazard! All biological specimens and materials coming into contact with them are considered biohazardous. Handle as if capable of transmitting infection. Dispose of waste using proper precautions and in accordance with local regulations. Never pipette by mouth. Wear suitable protective clothing, eyewear, and gloves.

When to check the waste container

Check the fluid levels in the waste container every time you use the cytometer. This ensures that the waste container does not become too full.

Waste container components

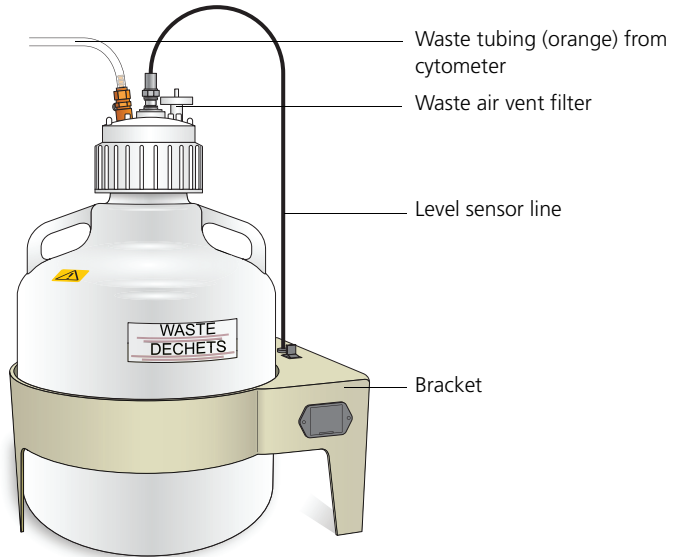

Cautions



Caution: Biohazard! To avoid leakage of biohazardous waste, put the cytometer in standby mode before disconnecting the waste container.

Caution: Biohazard! The waste container contents might be biohazardous. Treat contents with bleach (10% of total volume).



Caution! If the air vent filter on the top of the waste container cap assembly becomes clogged, air cannot be vented from the container, causing it to swell under pressure. If you observe swelling of the waste container, loosen the cap to relieve the pressure, and immediately replace the air filter. See [Replacing the waste air filter \(page 49\)](#) for instructions. Removing the air filter or the waste container cap assembly without first relieving the pressure might generate an unnoticeable aerosol. Use appropriate precautions when troubleshooting a clogged air filter. Wear suitable protective clothing, eyewear, and gloves.

Procedure

To prepare the waste container:

1. Verify that the flow cytometer is in standby mode.
Press the STNDBY button on the control panel if necessary.
2. Disconnect the orange waste tubing and the black level sensor line from the waste container. Keep the lid on the waste container until you are ready to empty it.
3. Empty the waste container.



Caution! The waste container is heavy when full. When emptying it, use good body mechanics to prevent injury.

4. Add approximately 1 L of bleach to the waste container and close it.
 5. Reconnect the orange waste tubing and make sure it is not kinked.
 6. Reconnect the level sensor line.
-

Priming the fluidics

About this topic

This topic describes how to prime the fluidics system.

When to prime the fluidics

Sometimes, air bubbles and debris may become lodged in the flow cell. This is indicated by excessive noise in the forward and side scatter parameters. In these cases, it is necessary to prime the fluidics system.

Procedure

To prime the fluidics:

1. Move the tube support arm to the side.
2. Remove the tube from the SIP.
3. Press the PRIME fluid control button to force the fluid out of the flow cell and into the waste container.

Once drained, the flow cell automatically fills with sheath fluid at a controlled rate to prevent bubble formation or entrapment. The STNDBY button turns amber after completion.

4. Repeat the priming procedure, if necessary.
 5. Install a 12 x 75-mm tube with 1 mL of DI water on the SIP and place the support arm under the tube. Leave the cytometer in standby mode.
-

Related topics

- [Cytometer troubleshooting \(page 116\)](#)
-

About the optical filters and mirrors

About this topic

This topic provides a description of the optical filters and mirrors.

Filter and mirror configurations

Each PMT (except the last PMT in every detector array) has two slots in front of it: a filter slot and a mirror slot.

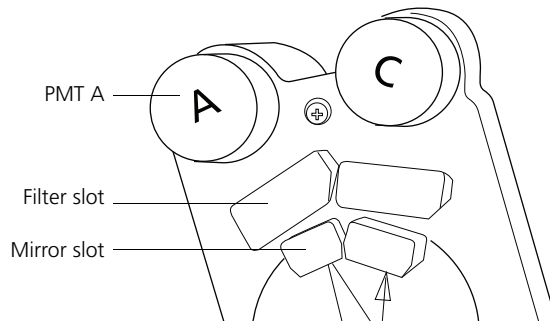

- **Filter slot.** The slot closer to the PMT that holds a bandpass filter holder.
- **Mirror slot.** The slot farther from the PMT that holds a longpass dichroic mirror holder.

The filters steer progressively shorter wavelengths of light to the next PMT in the array starting at PMT A.

Optic holders, filters, and mirrors

Optic holders house filters and mirrors. Your cytometer includes several blank (empty) optic holders.

Note: To ensure data integrity, do not leave any slots empty in a detector array when you are using the associated laser. Always use a blank optic holder.

Base configurations

Each BD LSRFortessa cytometer has a base cytometer configuration that corresponds to the layout of the installed lasers and optics in your cytometer. This base configuration is set by your field service engineer.

BD FACSDiva cytometer configuration

Before you acquire data using BD FACSDiva software, you must specify a cytometer configuration. The cytometer configuration defines which filters and mirrors are installed at each detector.

BD FACSDiva software provides a BD base configuration for your BD LSRFortessa cytometer. Select **Cytometer > View Configuration** to create, modify, or delete custom cytometer configurations. (See the Cytometer and Acquisition Controls chapter of the *BD FACSDiva Software Reference Manual* for details.)

Related topics

- [Changing optical filters and mirrors \(page 36\)](#)
 - [About the base configuration \(page 133\)](#)
 - [Special Order configurations \(page 149\)](#)
-

Changing optical filters and mirrors

About this topic

This topic describes how to verify that the optical filters are in the appropriate position for your particular requirements. Before you run samples, you must set up the optical filters.



Caution: Laser Hazard! Follow the precautions outlined in the *BD LSRFortessa Safety and Limitations Guide* while changing optical filters or mirrors.

Procedure

To change a filter or mirror:

1. Access the appropriate detector array.
 - Octagon or trigon arrays are located in the left side cytometer drawer.
 - Up to two trigon arrays are located in the front doors.
2. Remove the appropriate filter holder or mirror holder.
3. Replace the removed holder with the new filter or mirror holder.

The metal ring on the filter or mirror holder must face toward the center of the trigon or octagon. Verify that the filters are arranged so that the longest wavelength is in the A position and the shortest wavelength is in the last position used.

4. Close the cytometer side drawer or front door(s).

Related topics

- [Detector array configurations \(page 129\)](#)
-

Custom configurations and baselines

About this topic

This topic describes where to find information on how to create a custom configuration and define a baseline for a performance check.

Overview

BD™ Cytometer Setup and Tracking (CS&T) software is used to define the baseline performance of your cytometer. A baseline provides a starting point for the tracking of cytometer performance. When running a performance check, you compare the results to the baseline.

Some BP filters might not be normalized to CS&T settings. In this case, CS&T will generate Qr and Br numbers that are not comparable from instrument to instrument. They are however, still trackable on one cytometer. In addition, you must carefully check the PMT voltages that CS&T sets for these filters. See [Optimizing cytometer settings \(page 57\)](#). Please see the latest published filter guides available on our website (bdbiosciences.com) for more information.

See the *BD Cytometer Setup and Tracking Application Guide* for information on creating custom configurations and defining a baseline.

Related topics

- [Running a performance check \(page 64\)](#)
-

Need more information fast?

Information about this product is also available in your software's Help system.

You can keep the Help window open while you use the software or print the information directly from the window.

Internet access is not required to use the Help system.

4

Maintenance

This section covers the following topics:

- [Maintenance overview \(page 40\)](#)
- [Cleaning the fluidics \(page 41\)](#)
- [Shutting down the cytometer \(page 43\)](#)
- [Flushing the system \(page 44\)](#)
- [Maintaining the waste management system \(page 46\)](#)
- [Replacing the waste air filter \(page 49\)](#)
- [Changing the sheath filter \(page 50\)](#)
- [Changing the Bal seal \(page 52\)](#)
- [Changing the sample tube O-ring \(page 54\)](#)

Maintenance overview

About this topic

This topic provides an overview of the BD LSRFortessa routine maintenance and cleaning procedures.

General use guidelines



Caution: Biohazard! Coming into contact with all biological specimens and materials is considered biohazardous.

Follow these guidelines whenever operating or maintaining the cytometer:

- Handle all biological specimens and materials as if they are capable of transmitting infection.
- Dispose of waste using proper precautions and in accordance with local regulations.
- Never pipette by mouth.
- Wear suitable protective clothing, eyewear, and gloves.

For fluidics maintenance, we recommend the following cleaning solutions:

- BD™ FACSClean solution
- 10% bleach solution
- 0.5% solution of sodium hypochlorite

Use DI water to dilute bleach and sodium hypochlorite to appropriate concentrations.



Caution! Higher concentrations of sodium hypochlorite and use of other cleaning solutions might damage the cytometer.

When to perform maintenance procedures

Perform maintenance procedures in the following frequencies.

Frequency	Maintenance procedure
Daily	<ul style="list-style-type: none"> • Cleaning the fluidics (page 41) • Shutting down the cytometer (page 43)
Scheduled (every two weeks)	<ul style="list-style-type: none"> • Flushing the system (page 44) • Maintaining the waste management system (page 46)
Periodic (frequency depends on how often you run the cytometer)	<ul style="list-style-type: none"> • Changing the sheath filter (page 50) • Changing the Bal seal (page 52) • Changing the sample tube O-ring (page 54)

Cleaning the fluidics

About this topic

This topic describes how to perform the daily fluidics cleaning.

Overview

Cleaning the fluidics daily prevents the sample injection tube from becoming clogged and removes dyes that can remain in the tubing.

In addition to daily cleaning, follow this procedure immediately after running viscous samples or nucleic acid dyes such as Hoechst, DAPI, propidium iodide (PI), acridine orange (AO), or thiazole orange (TO).

Procedure**To clean the fluidics:**

1. Press RUN and HI on the cytometer fluid control panel.
2. Install a tube containing 3 mL of a cleaning solution on the SIP with the support arm to the side (vacuum on) and let it run for 1 minute.

For the cleaning solution, use BD FACSClean solution. See [Maintenance overview \(page 40\)](#) for other recommended cleaning solutions.

3. Move the tube support arm under the tube (vacuum off) and allow the cleaning solution to run for 5 minutes with the sample flow rate set to HI.
4. Repeat steps 2 and 3 with BD™ FACS Rinse solution.
5. Repeat steps 2 and 3 with DI water.
6. Press the STNDBY button on the fluidics control panel.
7. Place a tube containing no more than 1 mL of DI water on the SIP.

A tube with 1 mL of DI water should remain on the SIP to prevent salt deposits from forming in the injection tube. This tube also catches back drips from the flow cell.



Caution! Do not leave more than 1 mL of water on the SIP. When the instrument is turned off or left in standby mode, a small amount of fluid will drip back into the sample tube. If there is too much fluid in the tube, it could overflow and affect the cytometer performance.

Shutting down the cytometer

About this topic	This topic describes how to shut down the cytometer.
Before you begin	Each time you shut down the cytometer, perform the daily cleaning as described in Cleaning the fluidics (page 41) .
Procedure	<p>To shut down the cytometer:</p> <ol style="list-style-type: none">1. Place a tube of DI water on the SIP.2. Turn off the flow cytometer.3. Select Start > Shutdown to turn off the computer (if needed).4. If your system is using the BD FACSFlo supply system, shut off the BD FACSFlo supply system. <p>If the cytometer will not be used for a week or longer, perform a system flush and leave the fluidics system filled with DI water to prevent saline crystals from clogging the fluidics.</p>
Related topics	<ul style="list-style-type: none">• Cleaning the fluidics (page 41)• Flushing the system (page 44)

Flushing the system

About this topic

This topic describes how to perform an overall fluidics cleaning to remove debris and contaminants from the sheath tubing, waste tubing, and flow cell. Perform the system flush at least every 2 weeks.

Note: If you are using the BD FACSTFlow supply system, see the *BD FACSTFlow Supply System User's Guide* for instructions on flushing the system.

Cautions



Caution: Biohazard! The cytometer hardware might be contaminated with biohazardous material. Use 10% bleach to decontaminate the instrument.

Procedure

To perform a system flush:

1. Remove the sheath filter.
 - a. Press the quick-disconnects on both sides of the filter assembly.
 - b. Remove the filter assembly.
 - c. Connect the two fluid lines.



Caution! Do not run detergent, bleach, or ethanol through the sheath filter. They can break down the filter paper within the filter body, causing particles to escape into the sheath fluid, possibly clogging the flow cell.

2. Empty the sheath container and rinse it with DI water.
3. Fill the sheath container with at least 1 L of undiluted BD FACSClean solution.
4. Empty the waste container, if needed.
5. Open the roller clamp by the fluidics interconnect, and drain the fluid into a beaker for 5 seconds.

6. Remove the DI water tube from the SIP.
7. Prime the instrument twice:
 - a. Press the PRIME button on the fluidics control panel.
 - b. When the STNDBY button lights (amber), press the PRIME button again.
8. Install a tube with 3 mL of undiluted BD FACSClean solution on the SIP and put the tube support arm underneath the tube.

See [Maintenance overview \(page 40\)](#) for other recommended cleaning solutions.
9. Press RUN and HI on the cytometer fluid control panel. Run for 30 minutes.
10. Press the STNDBY fluid control button and depressurize the sheath container by lifting the vent valve.
11. Repeat steps [2](#) through [10](#) with BD FACSRinse solution.
12. Repeat steps [2](#) through [10](#) with DI water.
13. Replace the sheath filter and refill the sheath container with sheath fluid.

Next step

Test the waste management system battery as described in [Maintaining the waste management system \(page 46\)](#).

Maintaining the waste management system

About this topic

This topic describes how to maintain the waste management system. The waste management system has an alarm powered by a 9-volt battery that you must test and change regularly to ensure continued operation.

When to perform the battery test

Test the battery every two weeks after you flush the system. Change the battery as needed.

Testing the battery and alarm

To test the battery and alarm:

1. Locate the Battery Test switch on the waste container bracket.

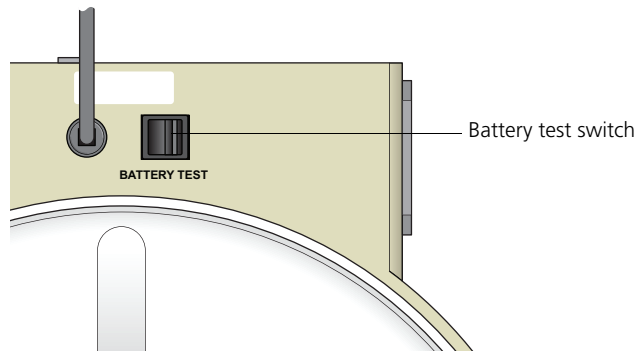

2. Toggle the switch.

If the battery and the alarm are working properly, you should hear an alarm buzzing. If you do not hear any sound, change the battery as described in the following section.

3. Release the switch.

Changing the battery

You need the following supplies to change the battery:

- Small flat-head screwdriver
- A 9-volt battery

To change the battery:

1. Insert the tip of a flat-head screwdriver into the slot and gently slide the battery drawer out.

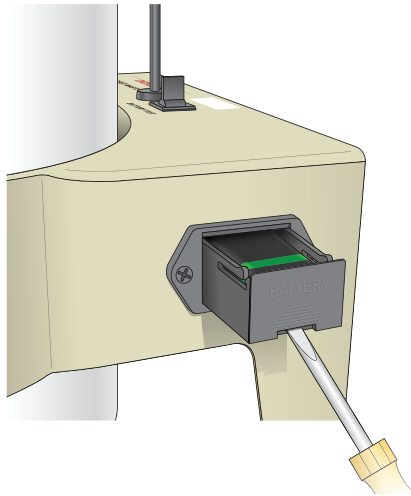

2. Remove the drawer.

3. Remove the battery from the drawer.



4. Place a new 9-volt battery into the drawer.
The markings in the battery drawer show the correct battery orientation.
 5. Slide the drawer into the bracket until you feel a click.
 6. Test the new battery.
-

Replacing the waste air filter

About this topic

This topic describes the procedure for replacing the waste air filter. An air filter is located on the cap assembly of the waste container.

Procedure



Caution: Biohazard! Treat a contaminated air filter as biohazardous waste.

To replace the air filter:

1. Remove the air filter.

Hold the silicone tubing with one hand and pull off the filter with the other hand.

2. Insert a new air filter into the silicone tubing.
 3. Verify that the cap assembly on the container is tightened.
-

Changing the sheath filter

About this topic

This topic describes how to change the sheath filter. The sheath filter is connected in-line with the sheath line. It filters the sheath fluid as it comes from the sheath container.

When to change the sheath filter

We recommend changing the sheath filter assembly every 6 months. Increased debris appearing in an FSC vs SSC plot can indicate that the sheath filter needs to be replaced. See [Supplies and consumables \(page 175\)](#) for ordering information.

Sheath filter components

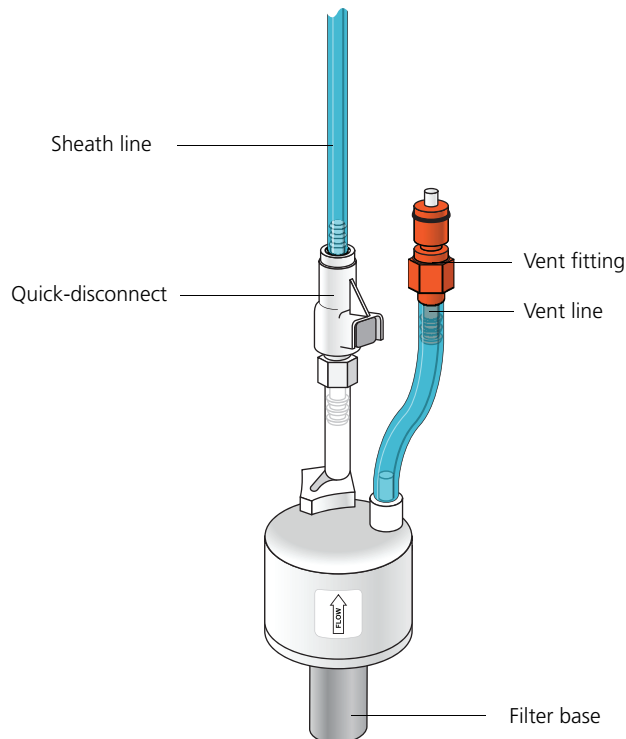

Removing the old filter**To remove the old filter:**

1. Place the cytometer in standby mode.
 2. Remove the sheath filter assembly by pressing the quick-disconnect on both sides of the filter assembly.
 3. Over a sink or beaker:
 - Remove the vent line from the filter and set it aside.
 - Remove the filter base and set it aside.
 4. Discard the used filter assembly in an appropriate receptacle.
-

Attaching the new filter**To attach the new filter:**

1. Connect the vent line to the new filter assembly.
Twist to attach.
 2. Wrap Teflon® tape around the filter threads, then connect the filter to the filter base.
 3. Connect the sheath line to the filter assembly by squeezing the quick-disconnect.
 4. Attach the cytometer fluid line to the filter assembly via the quick-disconnect.
 5. Direct the vent line into a beaker and press the small button at the end of the vent fitting against the side of the beaker until a steady stream of fluid empties from the filter.
 6. Tilt the filter and verify that no trapped air remains in the filter.
 7. Repeat steps 5 and 6 as necessary to remove all trapped air.
-

Changing the Bal seal

About this topic

This topic describes how to replace the Bal seal.

The sample injection tube Bal seal is a ring that forms a seal with the sample tube and ensures proper tube pressurization.

When to change the Bal seal

Over time, the Bal seal becomes worn or cracked and requires replacement. Replacement is necessary if a proper seal is not formed when a sample tube is installed on the SIP. Indications that a proper seal has not formed include:

- The tube will not stay on the SIP without the tube support arm.
 - When the tube is installed and RUN is pressed on the cytometer, the RUN button is orange (not green).
-

Procedure

To replace the Bal seal:

1. Remove the outer sleeve from the sample injection tube by turning the retainer counter-clockwise. Slide the outer sleeve down and off of the sample injection tube.

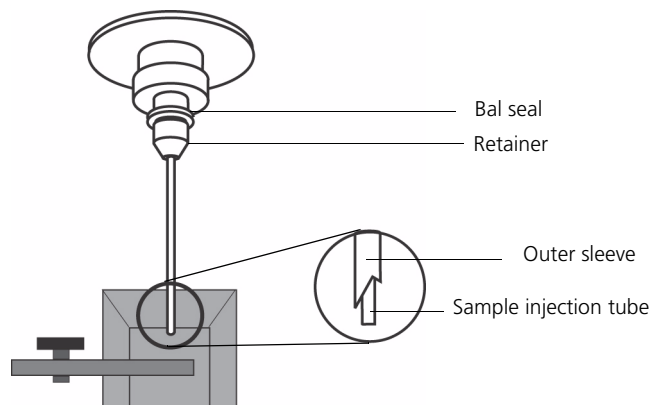

Work carefully. The outer sleeve can fall off as you loosen the retainer.

2. Remove the Bal seal by gripping it between your thumb and index finger and pulling down.

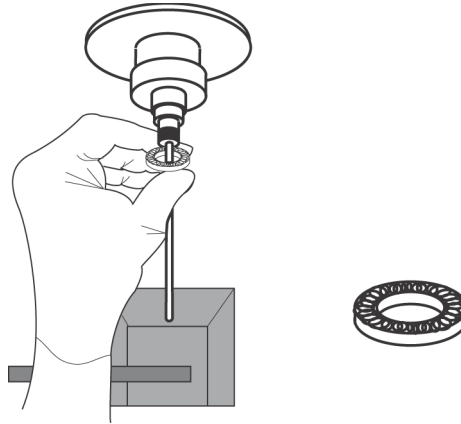

3. Install the new Bal seal spring-side up.
Ensure that the sample tube O-ring is still in place inside the retainer.
4. Re-install the retainer and outer sleeve over the sample injection tube. Push the outer sleeve all the way up into the sample injection port and then screw the retainer into place and tighten to finger tight. This will seat the Bal seal.
5. Install a sample tube on the SIP to ensure that the outer sleeve has been properly installed.

If the sleeve hits the bottom of the tube, loosen the retainer slightly and push the sleeve up as far as it will go. Tighten the retainer.

Changing the sample tube O-ring

About this topic

This topic describes how to replace the sample tube O-ring.

The sample tube O-ring, located within the retainer, forms a seal that allows the droplet containment vacuum to function properly.

When to replace the O-ring

Replace the O-ring when droplets form at the end of the sample injection tube while the vacuum is operating.

Caution



Caution: Biohazard! Cytometer hardware might be contaminated with biohazardous material. Wear suitable protective clothing, eyewear, and gloves whenever cleaning the cytometer or replacing parts.

Procedure

To change the O-ring:

1. Remove the outer sleeve from the sample injection tube by turning the retainer counter-clockwise.
2. Slide the outer sleeve from the retainer.

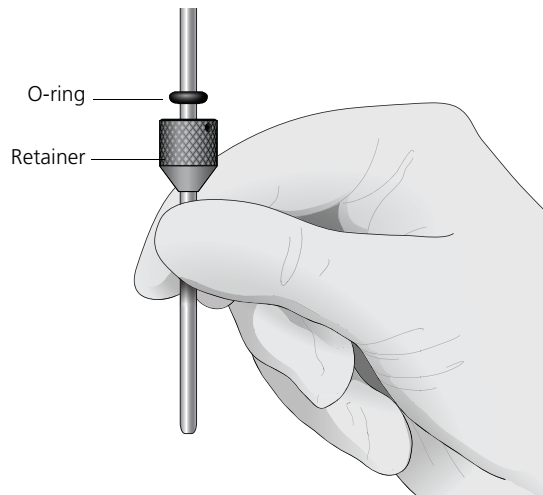

3. Invert the outer droplet sleeve and allow the O-ring to fall onto the benchtop.

If the O-ring does not fall out initially, hold the O-ring with your free hand and slide the outer sleeve to remove the O-ring.

4. Place the new O-ring into the retainer. Make sure the O-ring is seated properly in the bottom of the retainer.
5. Replace the outer sleeve in the retainer.
6. Re-install the retainer and the outer sleeve.
7. Install a sample tube on the SIP to ensure that the outer sleeve has been properly installed.

If the sleeve hits the bottom of the tube, loosen the retainer slightly and push the sleeve up as far as it will go. Tighten the retainer.

Need more information fast?

Information about this product is also available in your software's Help system.

You can keep the Help window open while you use the software or print the information directly from the window.

Internet access is not required to use the Help system.

5

Optimizing cytometer settings

This section includes the following topics:

- [Cytometer settings workflow \(page 58\)](#)
- [Verifying the configuration and user preferences \(page 61\)](#)
- [Running a performance check \(page 64\)](#)
- [Setting up an experiment \(page 69\)](#)
- [Creating application settings \(page 73\)](#)
- [Recording compensation controls \(page 76\)](#)
- [Calculating compensation \(page 80\)](#)

Cytometer settings workflow

About this topic	This topic describes how to optimize cytometer settings. The optimization is performed using the Cytometer Setup and Tracking, Application Settings, and Compensation Setup features of BD FACSDiva software.
When to optimize settings	Before you record data for a sample, optimize the cytometer settings for the sample type and fluorochromes used.
Manual compensation	Compensation setup automatically calculates compensation settings. If you choose to perform compensation manually, not all of the following instructions apply. For detailed instructions, see the <i>BD FACSDiva Software Reference Manual</i> .
First-time users	<p>If you are performing the procedures in this workflow for the first time, you should be familiar with BD FACSDiva software concepts: workspace components, cytometer and acquisition controls, and tools for data analysis.</p> <p>To become familiar with BD FACSDiva software, perform the tutorial exercises in <i>Getting Started with BD FACSDiva Software</i>.</p> <p>For additional details, see the <i>BD FACSDiva Software Reference Manual</i>.</p>
Before you begin	Start the BD LSRFortessa cytometer and perform the setup and QC procedures. See Cytometer setup (page 23) .

Workflow for optimizing settings

Cytometer optimization consists of the following steps.

Step	Description
1	Verifying the configuration and user preferences (page 61)
2	Running a performance check (page 64)
3	Setting up an experiment (page 69)
4	Creating application settings (page 73)
5	Recording compensation controls (page 76)
6	Calculating compensation (page 80)

Note: Application settings are optional and do not have to be saved for the experiments. However, they are useful for optimizing cytometer settings.

About the examples

The examples in this chapter use a 4-color bead sample with the following fluorochromes:

- FITC
- PE
- PerCP-Cy™5.5
- APC

If you follow this workflow with a different bead sample (or another sample type), your software views, data plots, and statistics might differ from the example. Additionally, you might need to modify some of the instructions in the procedure.

The information shown in italics is for example only. You can substitute your own names for folders and experiments.

Verifying the configuration and user preferences

About this topic

This topic describes how to verify the cytometer configuration and user preferences before you create an experiment.



Caution! To obtain accurate data results, the current cytometer configuration must reflect your BD LSRFortessa cytometer optics.

Procedure

To verify the configuration and preferences before you create an experiment:

1. Select **Cytometer > View Configurations** and verify the current configuration.

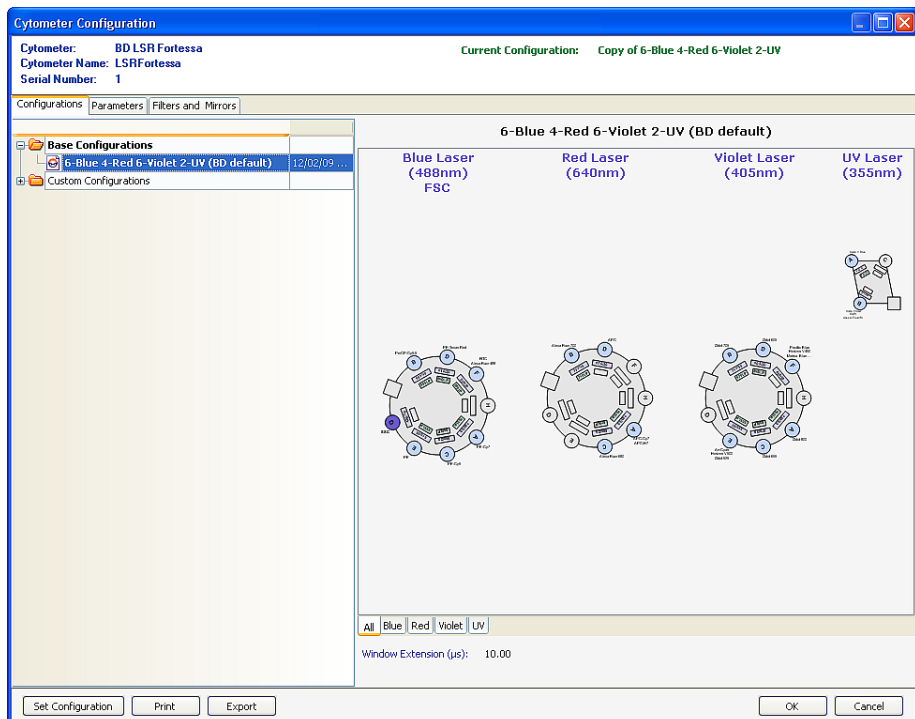

Your cytometer might include only the base configuration when your cytometer is installed. You can create additional configurations later as needed.

In this example, the cytometer configuration must include the following parameters: FITC, PE, PerCP-Cy5.5, and APC.

2. If you need to select a configuration other than the current configuration:
 - a. In the **Configurations** tab, select a configuration.
 - b. Click **Set Configuration**.
 - c. Click **OK**.
 - d. Verify that the configuration you just set matches your BD LSRFortessa cytometer optics.
3. Click **OK** to close the **Cytometer Configuration** window.
4. Select **File > Exit** to close CS&T.
5. Select **Edit > User Preferences**.

6. Click the **General** tab and select the **Load data after recording** checkbox.

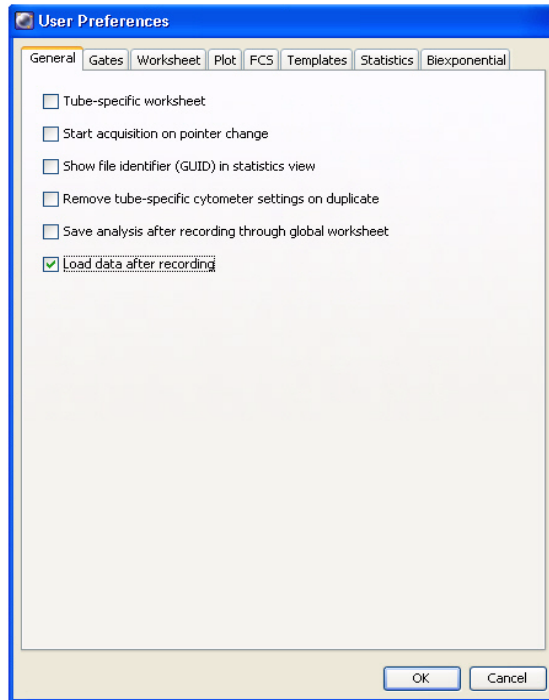

See the *BD FACSDiva Software Reference Manual* for more information about cytometer configurations and user preferences.

Related topics

- [Setting up an experiment \(page 69\)](#)
-

Running a performance check

About this topic This topic describes how to run a performance check as part of quality control.

Overview The CS&T application is designed to monitor performance on a daily basis and to optimize laser delay.

Running a performance check on a regular basis provides a standard for monitoring changes in performance due to degradation of laser power, aging of PMTs, and other potential cytometer service issues. Performance results are also affected by fluidics performance. We strongly recommend following the fluidics maintenance procedures as described in [Cleaning the fluidics \(page 41\)](#).

Considerations Some BP filters might not be normalized to CS&T settings. In this case, CS&T will generate Qr and Br numbers that are not comparable from instrument to instrument. They are however, still trackable on one cytometer. Part of the process for optimizing cytometer settings includes verifying PMT voltages set by CS&T for all parameters. Carefully examine any channel with a non-CS&T normalized filter.

Before you begin Define the performance baseline for any configuration before running a performance check. See [Custom configurations and baselines \(page 37\)](#).

Procedure

To run a performance check:

1. Select Cytometer > CST.

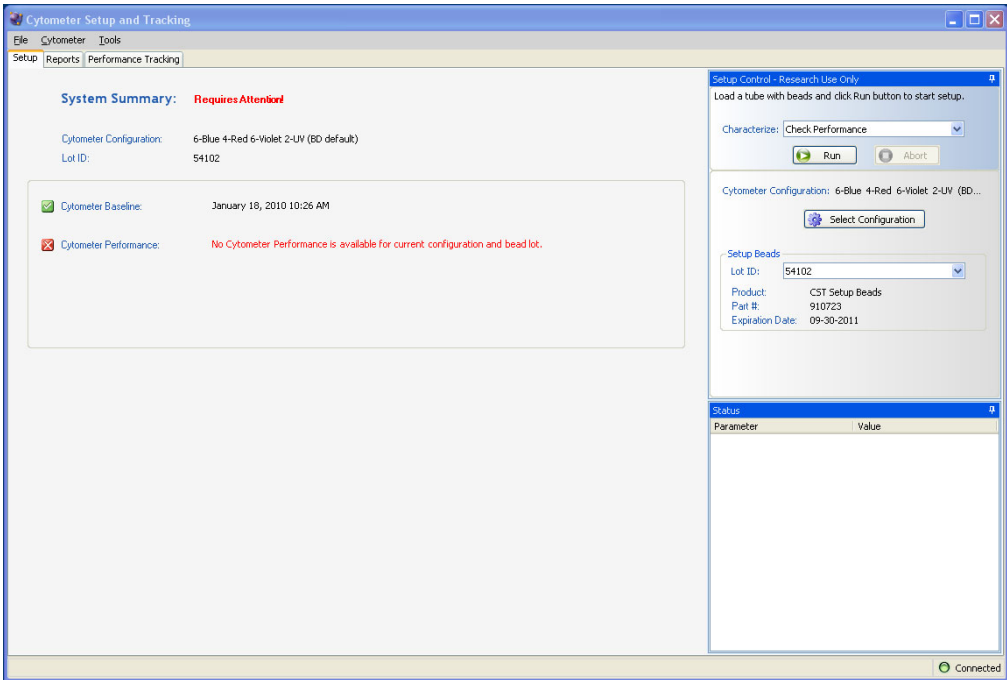

2. Verify that the bead lot information under **Setup Beads** matches the Cytometer Setup and Tracking bead lot.

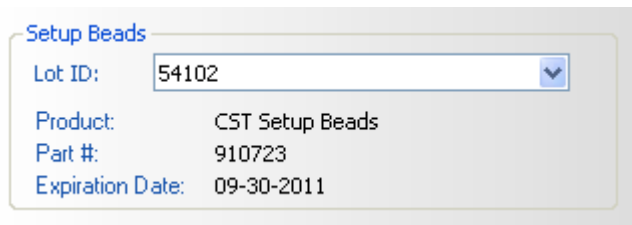

3. Verify that the cytometer configuration is correct for your experiment.



If the cytometer is not set to the correct configuration:

- a. Click **Select Configuration** in the **Setup Control** window.
 - b. Select the correct configuration from the list.
 - c. Click **Set Configuration** and then click **OK**.
4. Verify that the current configuration has a valid baseline defined.

If not, see the *BD Cytometer Setup and Tracking Application Guide* for more information on defining a baseline.

5. Prepare the CS&T beads according to the technical data sheet provided with the beads or available on the BD Biosciences website (bdbiosciences.com).
6. Install the bead tube onto the SIP.
7. In the **Setup Control** window, select **Check Performance** from the **Characterize** menu.

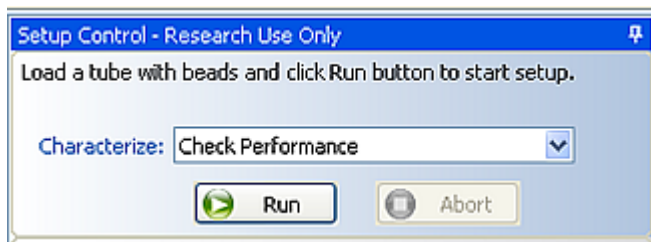

8. Click **Run**.
9. Ensure that the SAMPLE FINE ADJ knob is set to the midpoint and press RUN and LO.

Plots appear under the **Setup** tab and the performance check is run. The performance check takes approximately 5 minutes to complete.

10. Once the performance check is complete, click **View Report**.
11. Verify that the cytometer performance passed.

In the **Setup** tab, the cytometer performance results should have a green checkbox displayed and the word *Passed* next to it.

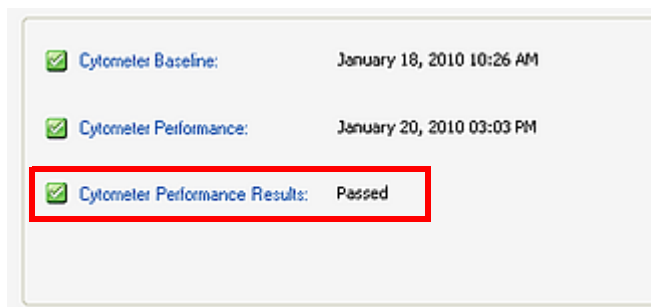

If any parameters did not pass, see the *BD Cytometer Setup and Tracking Application Guide* for troubleshooting information.

12. Select **File > Exit** to close the CS&T window and return to the BD FACSDiva interface.

The CST Mismatch dialog appears.

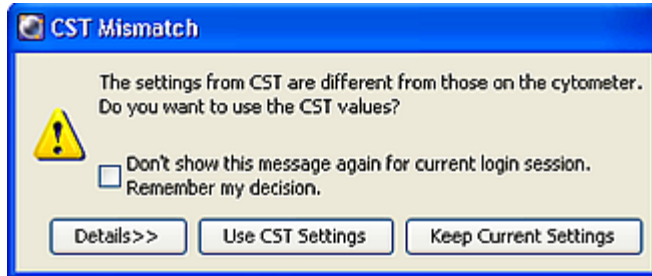

Click the **Details** button to verify which cytometer settings will be updated.

13. Click **Use CST Settings**.

By selecting **Use CST Settings**, the laser delay, area scaling, and other cytometer settings will be updated to the latest settings from the performance check.

Next step

Continue the optimization of your cytometer for an experiment or sample type as described in [Setting up an experiment \(page 69\)](#).

Setting up an experiment

About this topic

This topic describes how to create an experiment in a new folder, specify the parameters of the experiment, and add compensation tubes.

Creating an experiment

To create an experiment:

1. Click the buttons on the **Workspace** toolbar to display the following windows as needed:
 - Browser
 - Cytometer
 - Inspector
 - Worksheet
 - Acquisition Dashboard

When you add elements or make selections in the **Browser**, the **Inspector** displays details, properties, and options that correspond to your selection.

2. Click the **New Folder** button on the **Browser** toolbar to add a new folder.
3. Click the folder and rename it *MyFolder*.
4. Click *MyFolder*, then click the **New Experiment** button on the **Browser** toolbar.

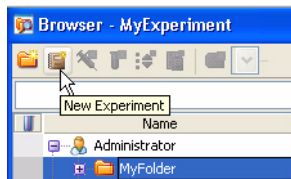

- a. Click the new experiment in the **Browser** and rename it *MyExperiment*.

5. Select *MyExperiment* in the **Browser**.

The **Inspector** displays details for the experiment.

Specifying parameters

To specify the parameters for the new experiment:

1. Select **Cytometer Settings** for the experiment in the **Browser**.

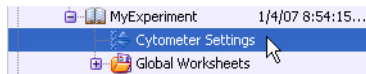

Cytometer settings appear in the **Inspector**.

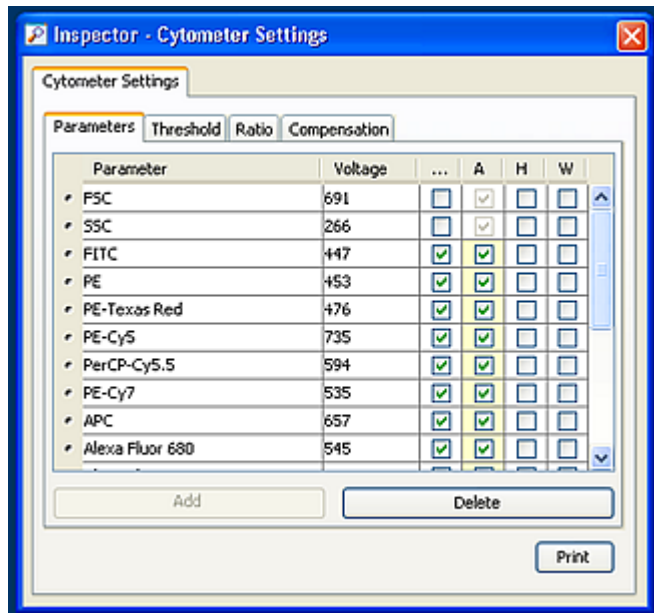

2. Make sure the parameters you need appear on the **Parameters** tab in the **Inspector**.

If more than one parameter is available for a particular PMT, you might have to select the one you need from a menu. For example, you can set Detector F for the blue laser as FITC or Alexa Fluor® 488.

- a. Click the **Parameter** name to display the available fluorochromes in the **Parameters** list.

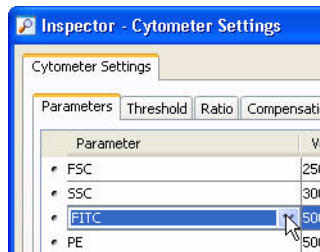

- b. Select the specific parameter from the drop-down menu. Your selection appears as the selected parameter.

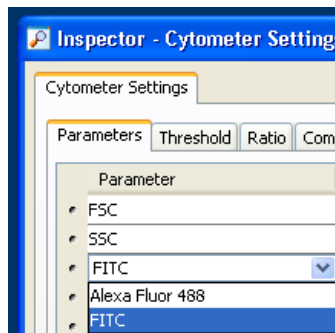

- c. For this example, select **FITC** from the menu.

3. Delete any unnecessary parameters.
 - a. Click the selection button (to the left of the parameter name) to select the parameter.

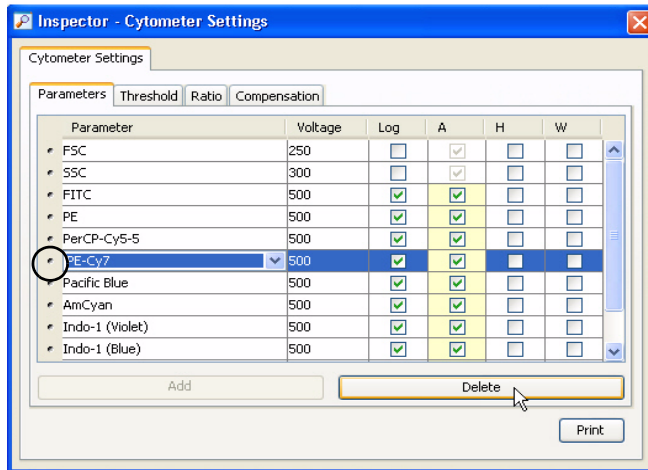

- b. Click **Delete**. The parameter is deleted.

Creating application settings

About this topic

This topic describes how to create application settings.

About application settings

Application settings are associated with a cytometer configuration and include the parameters for the application, area scaling values, PMT voltages, and threshold values, but not compensation. Each time a performance check is run for a configuration, the application settings associated with that configuration are updated to the latest run.

Using application settings provides a consistent and reproducible way to reuse cytometer settings for commonly used applications.

You can include area scaling adjustment in your application settings. See [Adjusting area scaling \(page 168\)](#) for more information.

Before you begin

Perform the cytometer setup procedure and run a performance check for the configuration that will be used for the application.

Procedure

To create application settings:

1. In the open experiment, right-click **Cytometer Settings** in the **Browser**, then select **Application Settings > Create Worksheet**.

A second global worksheet is added with the plots created according to the selections in the **Parameters** tab.

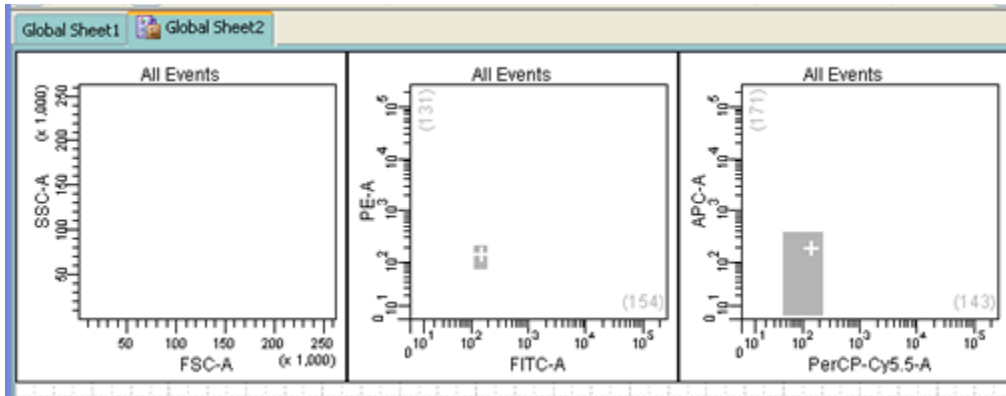

Use the gray boxes and crosshairs to guide your optimization.

2. Load the unstained control tube onto the cytometer.
3. In the **Cytometer** window, optimize the PMT voltages for the application.
 - Optimize the FSC and SSC voltages to place the population of interest on scale.
 - Optimize the FSC threshold value to eliminate debris without interfering with the population of interest.
 - If needed, increase the fluorescence PMT voltages to place the negative population within the gray boxes. Align the center of the negative population with the crosshair visible in the gray box.

Note: Do not decrease the fluorescence PMT voltages. Doing so can make it difficult to resolve dim populations from the negative population.

4. Unload the unstained control tube from the cytometer.
5. Load the multicolor sample onto the cytometer or load single-color control tubes and verify each fluorochrome signal separately.

6. Verify that the positive populations are on scale.
If a positive population is off scale, lower the PMT voltage for that parameter until the positive population can be seen entirely on scale.
7. Unload the multicolor sample.
8. Place a tube containing DI water on the SIP and put the cytometer on standby.
9. (Optional) Save the application settings by right-clicking **Cytometer settings** in the **Browser**, then selecting **Application Settings > Save**.
10. In the **Save Application Settings** dialog, enter a descriptive name for the application settings.

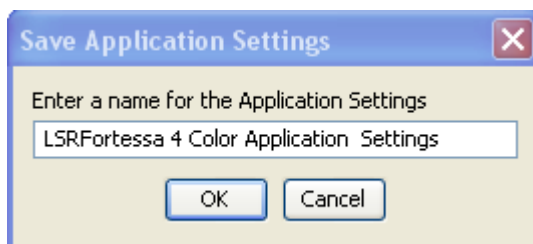

11. Click **OK**.

The application settings are saved to the catalog.

Recording compensation controls

About this topic

This topic describes how to create and record compensation controls using the Compensation Setup feature of BD FACSDiva software and an experiment with optimized settings.

Creating compensation tubes

To create compensation control tubes:

1. Select **Experiment > Compensation Setup > Create Compensation Controls**.

The **Create Compensation Controls** dialog opens.

For this bead example, you do not need to provide non-generic tube labels.

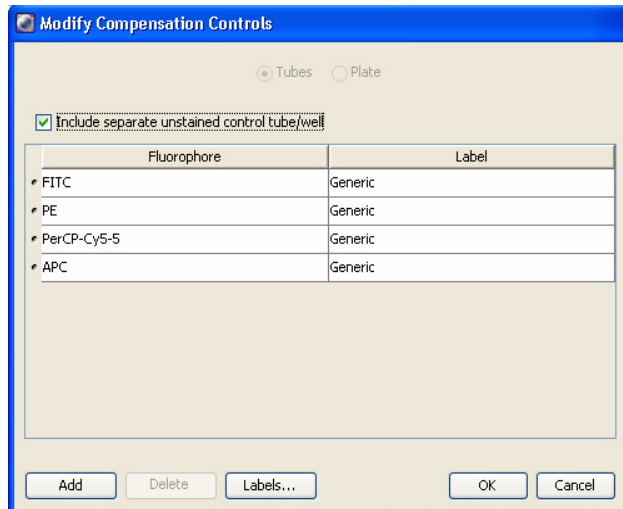

2. Click **OK**.

Compensation control tubes are added to the experiment. Worksheets containing appropriate plots and gates are added for each compensation tube.

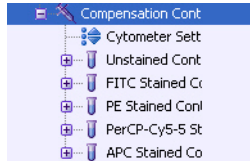

Recording compensation settings

To record compensation settings:

1. Press RUN and HI on the cytometer fluid control panel.
2. Install the unstained control tube onto the SIP.
3. Expand the **Compensation Controls** specimen in the **Browser**.
4. Set the current tube pointer to the unstained control tube (it becomes green), then click **Acquire Data** in the **Acquisition Dashboard**.
5. Verify that the population of interest is displayed appropriately on the FSC vs SSC plot and adjust voltages if necessary.

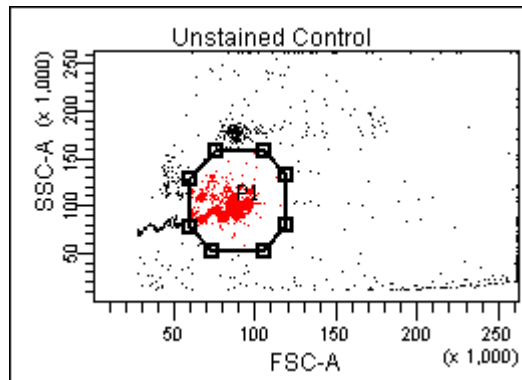

Since the application settings have been optimized for your sample, the cytometer settings should not require adjustment other than the changing of FSC and SSC voltages to place the beads on scale.

6. Adjust the P1 gate to surround only the singlets.
7. Right-click the P1 gate and select **Apply to All Compensation Controls**.

The P1 gate on each stained control worksheet is updated with your changes.

8. Click **Record Data**.
9. When recording is finished, remove the unstained control tube from the cytometer.
10. Click **Next Tube**.



Caution! Do not change the PMT voltages after the first compensation control has been recorded. In order to calculate compensation, all controls must be recorded with the same PMT voltage settings. If you need to adjust the PMT voltage for a subsequent compensation control, you must record all compensation controls again.

11. Install the next tube onto the cytometer and repeat steps [8](#) through [10](#) until data for all stained control tubes has been recorded.
12. Double-click the first stained control tube to display the corresponding worksheet.

- Verify that the snap-to interval gate encompasses the positive population.

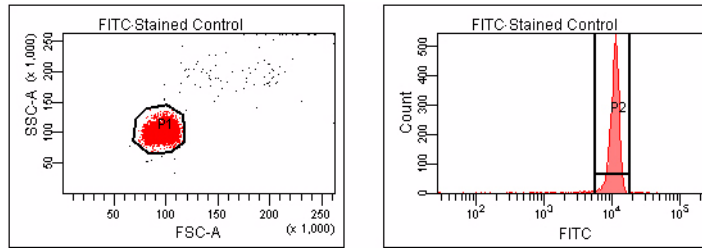

- Repeat steps 12 and 13 for the remaining compensation tubes.

Next step

After you have recorded data for each single-stained control, calculate compensation as described in [Calculating compensation \(page 80\)](#).

Calculating compensation

About this topic

This topic describes how to calculate compensation.

Before you begin

Before you can calculate compensation, you need to record the data for each single-stained control.

Procedure

To calculate compensation:

1. Select **Experiment > Compensation Setup > Calculate Compensation**.

Note: If the calculation is successful, a dialog is displayed where you can enter a name for the compensation setup.

Note: The default name is year/month/day/time.

2. Enter a setup name and click **Link & Save**.

The compensation is linked to the cytometer settings and saved to the catalog.

To help track compensation setups, include the experiment name, date, or both in the setup name.

The compensation setup is linked to the *MyExperiment* cytometer settings, and subsequent acquisitions in *MyExperiment* are performed with the new compensation settings.

We recommend that you always visually and statistically inspect automatically calculated spectral overlap values. The means of the positive controls should be aligned with the means of the negative controls.

Related topics

- [Recording compensation controls \(page 76\)](#)
-

6

Recording and analyzing data

This section includes the following topics:

- [Data recording and analysis workflow \(page 82\)](#)
- [Preparing the workspace \(page 83\)](#)
- [Recording data \(page 85\)](#)
- [Analyzing data \(page 88\)](#)
- [Reusing an analysis \(page 94\)](#)

Data recording and analysis workflow

About this topic

This topic outlines the basic acquisition and analysis tasks using BD FACSDiva software.

About the examples

The examples in this chapter is from two 4-color bead samples with the following fluorochromes:

- FITC
- PE
- PerCP-Cy5.5
- APC

If you use a different sample type or if you have skipped the optimization steps in [Optimizing cytometer settings \(page 57\)](#), your software window content, names of folders and experiments, and your data plots and statistics might differ from those shown here. You might also need to modify some of the instructions in the procedure.

For additional details on completing some of the following steps, see the *BD FACSDiva Software Reference Manual*.

This procedure builds on the results obtained in [Optimizing cytometer settings \(page 57\)](#).

Workflow for recording and analyzing data

Recording and analyzing data consists of the following steps.

Step	Description
1	Preparing the workspace (page 83)
2	Recording data (page 85)
3	Analyzing data (page 88)
4	Reusing an analysis (page 94)

Preparing the workspace

About this topic

This topic describes how to prepare the workspace and apply application settings to your experiment before recording data.

Procedure

To prepare the workspace:

1. Using the **Browser** toolbar, create a new specimen in *MyExperiment* and rename it *FourColorBeads*.
2. Create two tubes for the *FourColorBeads* specimen. Rename the tubes *Beads_001* and *Beads_002*.
3. Expand the **Global Worksheets** folder in *MyExperiment* to access the default global worksheet, and rename the worksheet *MyData*.

4. On the *MyData* worksheet, create the following plots for previewing the data:
 - FSC vs SSC
 - FITC vs PE
 - FITC vs PerCP-Cy5.5
 - FITC vs APC

Applying saved application settings to a new experiment

When applications settings are applied to an experiment, the cytometer settings are updated with the parameters included in the application settings, optimized PMT voltages, threshold settings, area scaling factors, and window extension values.

To apply saved application settings to your experiment:

1. Right-click the experiment-level Cytometer Settings and select **Application Settings > Apply**.
2. In the **Application Settings** catalog, select the application settings file you saved previously and click **Apply**.

If the parameters are not the same, a mismatch dialog opens.

- Click **Overwrite** to update all settings.
- Click **Apply** to change only the common parameters.

For more information, see the *BD FACSDiva Software Reference Manual*.

The cytometer settings are renamed application settings and the cytometer settings icon in the **Browser** changes.

Related topics

- [Creating application settings \(page 73\)](#)
- [Recording data \(page 85\)](#)

Recording data

About this topic

This topic provides an example of how to preview and record data for multiple samples.

Before you begin

Prepare the sample tubes.

Recording data

To record data:

1. Press RUN and HI on the cytometer fluid control panel.
2. Install the first sample tube onto the SIP.
3. Set the current tube pointer to *Beads_001*.
4. Click **Acquire Data** in the **Acquisition Dashboard** to begin acquisition.
5. While data is being acquired:
 - Draw a gate around the singlets on the FSC vs SSC plot.
 - Rename the P1 gate to *Singlets*.
 - Use the **Inspector** to set the other plots to show only the singlet population by selecting the Singlets checkbox.

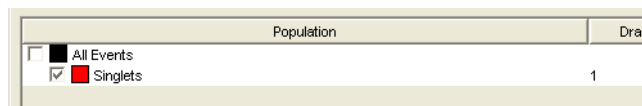

6. Click **Record Data**.

- When event recording has completed, remove the first tube from the cytometer.

The *MyData* worksheet plots should look like the following.

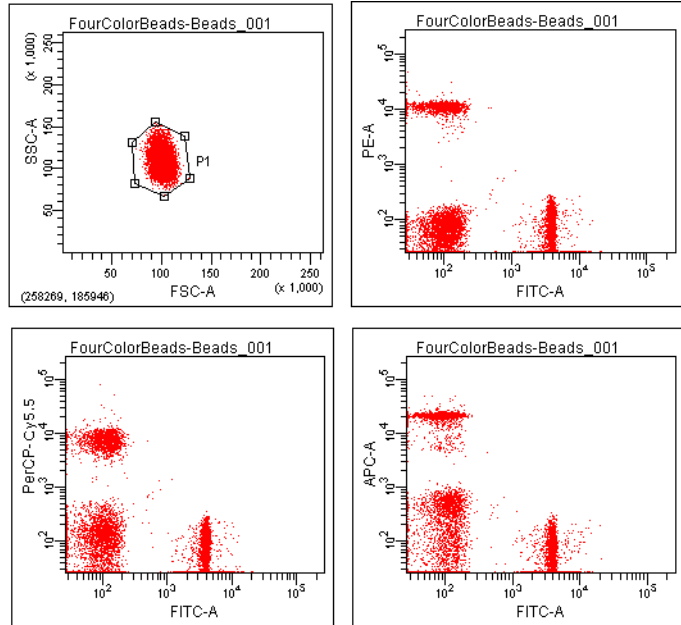

- Install the second sample tube onto the SIP.
- Set the current tube pointer to *Beads_002*.
- Click **Acquire Data** to begin acquisition.
- Before recording, preview the data on the *MyData* worksheet to verify that all expected populations are visible and the data is similar to the previous sample.
- Click **Record Data**.
- When event recording has completed, remove the second tube from the cytometer.

14. If you are recording more than two tubes, repeat steps 8 through 13 for the remaining tubes.
15. Print the experiment-level cytometer settings by right-clicking the **Cytometer Settings** icon in the **Browser** and selecting **Print**.
16. Install a tube of DI water onto the SIP.
17. Place the cytometer in standby mode.

Related topics

- [Analyzing data \(page 88\)](#)
-

Analyzing data

About this topic

This topic describes how to analyze recorded tubes by creating plots, gates, a population hierarchy, and statistics views on a new global worksheet.

Analyzing data

To analyze data:

1. Use the **Browser** toolbar to create a new global worksheet. Rename it *MyDataAnalysis*.
2. Create the following plots on the *MyDataAnalysis* worksheet:
 - FSC vs SSC
 - FITC vs PE
 - FITC vs PerCP-Cy5.5
 - FITC vs APC
3. Create a population hierarchy and a statistics view, and set them below the plots on the worksheet.
 - Right-click any plot and select **Show Population Hierarchy**.
 - Right-click any plot and select **Create Statistics View**.
4. Set the current tube pointer to *Beads_001*.
5. Draw a gate around the singlets on the FSC vs SSC plot.
6. Use the population hierarchy to rename the population *Singlets*.

7. Select all plots except the FSC vs SSC plot, and use the **Plot** tab in the **Inspector** to specify to show only the singlet population.

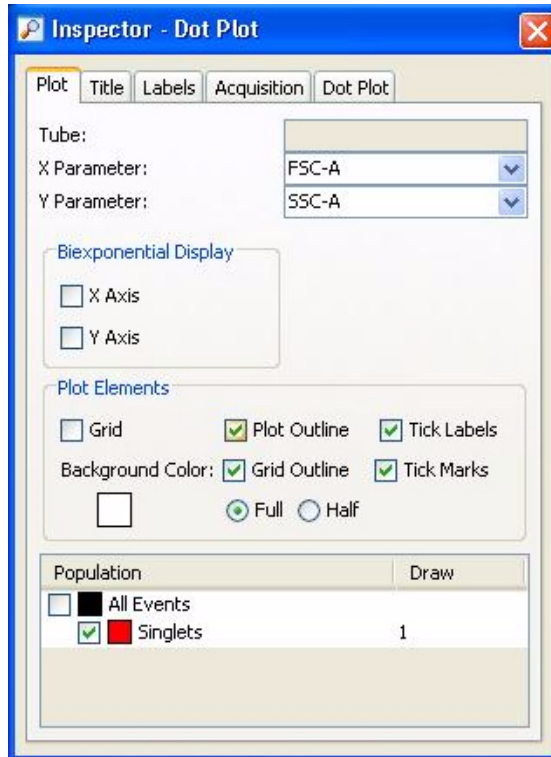

8. Select all plots, and click the **Title** tab in the **Inspector**. Select the **Tube** and **Populations** checkboxes to display their names in plot titles.

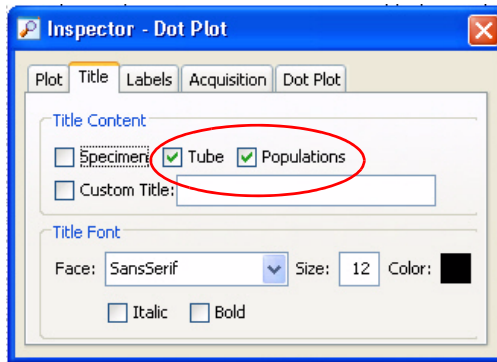

9. On all fluorescence plots:
 - Make all plots biexponential. Select all fluorescence plots and select the **X Axis** and **Y Axis** checkboxes in the **Plot** tab of the **Inspector**.

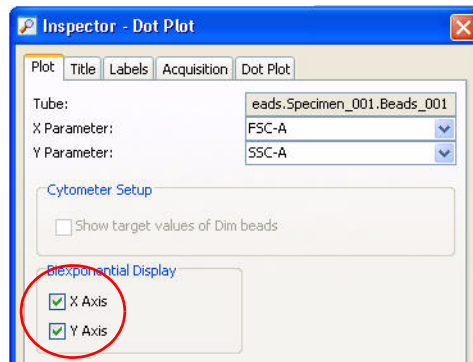

- In the FITC vs PE plot, draw a gate around the FITC-positive population. Name the population *FITC positive* in the population hierarchy.

- In the FITC vs PE plot, draw a gate around the PE-positive population. Name the population *PE positive* in the population hierarchy.
 - In the FITC vs PerCP-Cy5.5 plot, draw a gate around the PerCP-Cy5.5-positive population. Name the population *PerCP-Cy5.5 positive* in the population hierarchy.
 - In the FITC vs APC plot, draw a gate around the APC-positive population. Name the population *APC positive* in the population hierarchy.
10. Format the statistics view.
- a. Right-click the statistics view and select **Edit Statistics View**.
 - b. Click the **Header** tab and select the **Specimen Name** and **Tube Name** checkboxes.
 - c. Click the **Populations** tab and select all populations except **All Events**. Clear the **%Parent**, **%Total**, and **#Events** checkboxes.
 - d. Click the **Statistics** tab and select the mean for each of the fluorescence parameters.

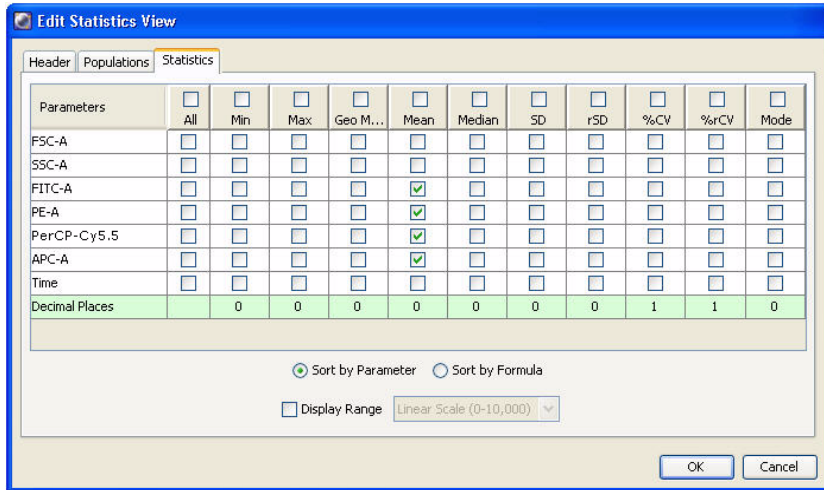

e. Click **OK**.

11. Print the analysis.

Your global worksheet analysis objects should look like the following.

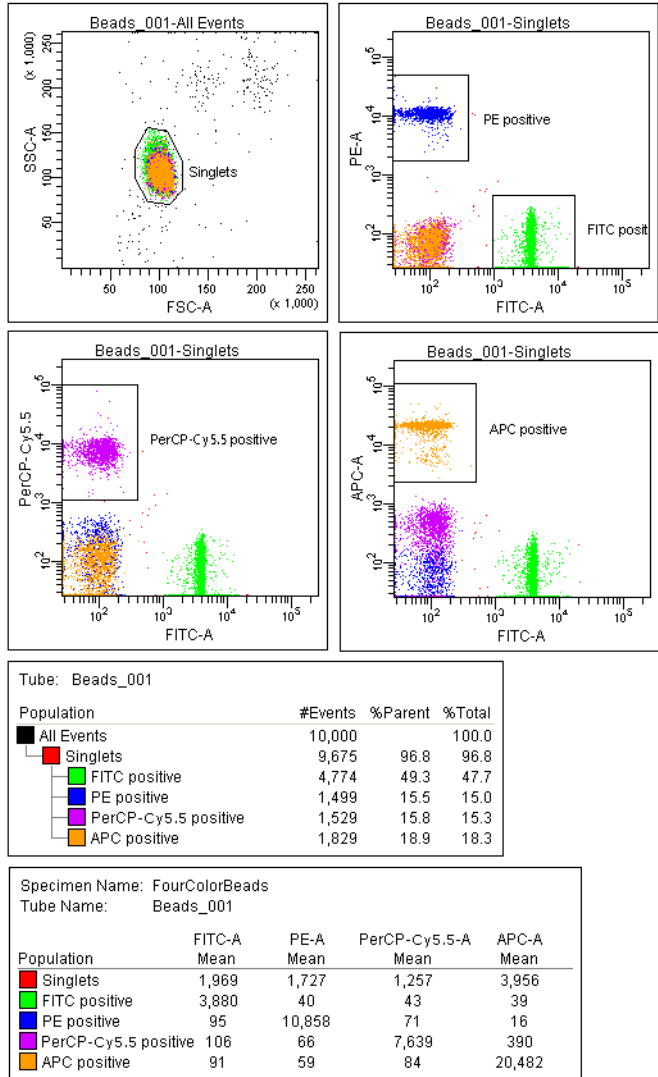

Related topics

- [Reusing an analysis \(page 94\)](#)
-

Reusing an analysis

About this topic

This topic describes how to use a global worksheets to apply the same analysis to a series of recorded tubes. Once you define an analysis for a tube, you can use it to analyze the remaining tubes in the experiment. After viewing the data, print the analysis or save it to a normal worksheet.

Reusing an analysis**To reuse the analysis:**

1. Set the current tube pointer to the *Beads_002* tube.
2. View the *Beads_002* data on your analysis worksheet. Adjust the gates as needed.

Adjustments apply to subsequent tubes viewed on the worksheet. To avoid altering a global worksheet, save an analysis to a normal worksheet, then make adjustments on the normal worksheet.

3. Print the analysis.
-

Saving the analysis

When you perform analysis with a global worksheet, the analysis does not save with the tube.

If you define your analysis on a global worksheet before recording data, you can specify to automatically save the analysis after recording data. You set this option in **User Preferences**.

To save a copy of the analysis with a tube:

1. Expand the *MyDataAnalysis* global worksheet icon in the **Browser**.

2. Right-click its analysis and select **Copy**.

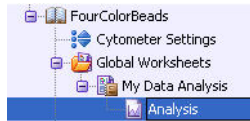

3. Click the **Worksheets View** button on the **Worksheet** toolbar to switch to the normal worksheet view.
4. Select **Worksheet > New Worksheet** to create a new normal worksheet.
5. Right-click the *Beads_001* tube icon in the **Browser**, and select **Paste**.

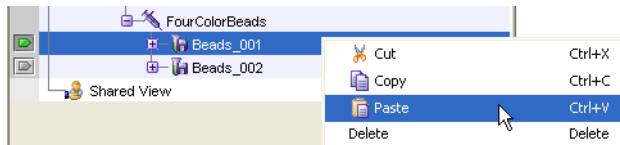

The analysis objects from the *MyDataAnalysis* global worksheet are copied to the *Beads_001_Analysis* normal worksheet. Double-click the *Beads_001* tube in the **Browser** to view the analysis.

Applying an analysis to normal worksheets

You can apply the global worksheet analysis to multiple tubes (on a single normal worksheet) by selecting multiple tubes before pasting the analysis. Ensure that you collapse all tube elements in the **Browser** before you paste them to multiple tubes.

Related topics

- [Analyzing data \(page 88\)](#)

Need more information fast?

Information about this product is also available in your software's Help system.

You can keep the Help window open while you use the software or print the information directly from the window.

Internet access is not required to use the Help system.

7

Technical overview

This section contains a technical overview of the following topics:

- [About fluidics \(page 98\)](#)
- [About optics \(page 100\)](#)
- [About electronics \(page 111\)](#)

About fluidics

About this topic

This topic describes the fluidics system in the BD LSRFortessa flow cytometer.

Pressure-driven fluidics system

The fluidics system in the BD LSRFortessa flow cytometer is pressure driven. A built-in air pump provides a sheath pressure of 5.5 psi. After passing through the sheath filter, sheath fluid is introduced into the lower chamber of the quartz flow cell.

Hydrodynamic focusing

The sample to be analyzed arrives in a separate pressurized stream. When a sample tube is placed on the SIP, the sample is forced up and injected into the lower chamber of the flow cell by a slight overpressure relative to the sheath fluid. The conical shape of the lower chamber creates a laminar sheath flow that carries the sample core upward through the center of the flow cell, where the particles to be measured are intercepted by the laser beam. This process is known as hydrodynamic focusing.

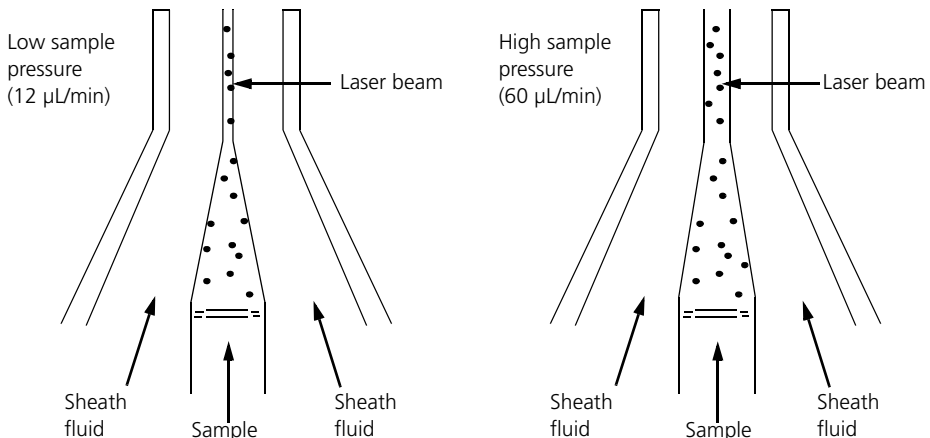

The objective in flow cytometric analysis is to have at most one cell or particle moving through a laser beam at a given time. The difference in pressure between the sample stream and sheath fluid stream can be used to vary the diameter of the sample core.

Increasing the sample pressure increases the sample flow rate thereby increasing the core diameter. The flow rate should be set according to the type of application you are running.

- A higher flow rate is generally used for qualitative measurements such as immunophenotyping. The data is less resolved, but is acquired more quickly.
- A lower flow rate is generally used in applications where greater resolution and quantitative measurements are critical, such as DNA analysis.

Proper operation of fluidic components is critical for particles to intercept the laser beam properly. Always ensure that the fluidics system is free of air bubbles and debris, and is properly pressurized.

About optics

About this topic

This topic describes the optics system and provides information about:

- [Light scatter](#) on this page
 - [Fluorescence \(page 101\)](#)
 - [Optical filter theory \(page 103\)](#)
 - [Compensation theory \(page 108\)](#)
-

Optics system

The optics system consists of lasers, optical filters, and detectors. Lasers illuminate the cells or particles in the sample and optical filters direct the resulting light scatter and fluorescence signals to the appropriate detectors.

Light scatter

When a cell or particle passes through a focused laser beam, laser light is scattered in all directions. Light that scatters axial to the laser beam is called forward scatter (FSC) and light that scatters perpendicular to the laser beam is called side scatter (SSC).

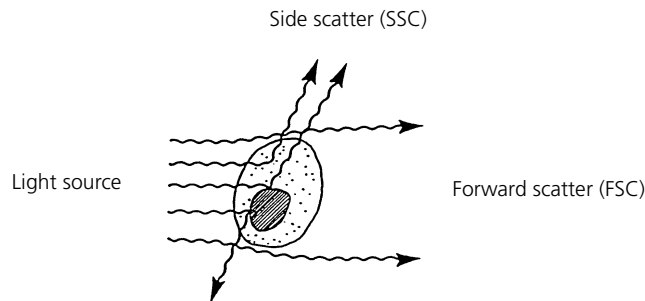

FSC and SSC are related to certain physical properties of cells.

- **FSC.** Indicates relative differences in the size of the cells or particles. Larger cells scatter more light and therefore they are higher in FSC.
- **SSC.** Indicates relative differences in the internal complexity or granularity of the cells or particles. More granular cells deflect more light than less granular cells, and therefore are higher in SSC.

Fluorescence

When cells or particles stained with fluorochrome-conjugated antibodies or other dyes pass through a laser beam, the dyes can absorb photons (energy) and be promoted to an excited electronic state. In returning to their ground state, the dyes release energy, most of which is emitted as light. This light emission is known as fluorescence.

Fluorescence is always a longer wavelength (lower-energy photon) than the excitation wavelength. The difference between the excitation wavelength and the emission wavelength is known as the Stokes shift. Some fluorescent compounds such as PerCP exhibit a large Stokes shift, absorbing blue light (488 nm) and emitting red light (675 nm), while other fluorochromes such as FITC have a smaller Stokes shift, absorbing blue light (488 nm) and emitting green light (530 nm).

The following figure shows the emission spectra of some commonly used fluorochromes.

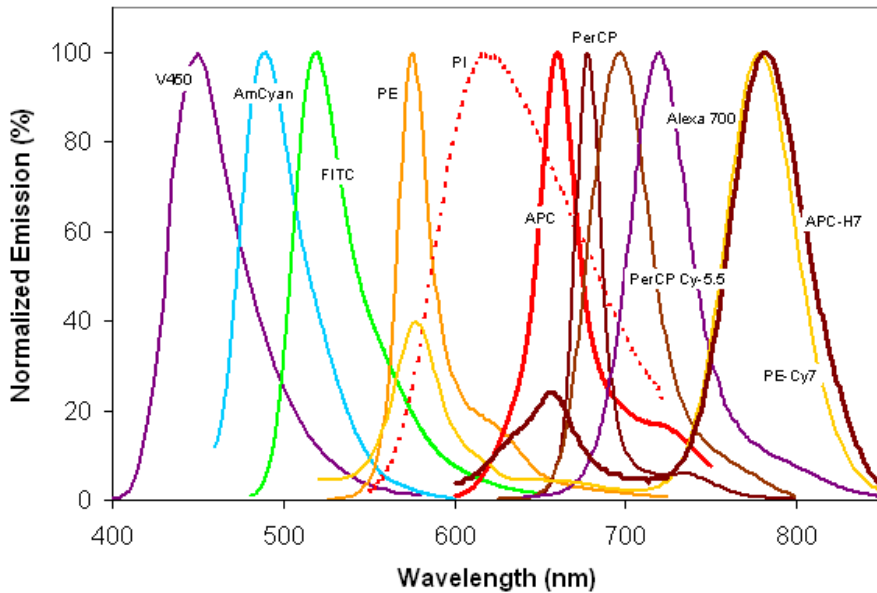

Actual emission intensity will depend on excitation wavelength. See [Fluorescence spectra \(page 130\)](#) for more information on excitation and emission of fluorochromes. An interactive spectral viewer is also available at bdbiosciences.com/colors/fluorescence_spectrum_viewer.

Optical filter theory

Optical filters modify the spectral distribution of light scatter and fluorescence directed to the detectors. When photons encounter an optical filter, they are either transmitted, absorbed, or reflected.

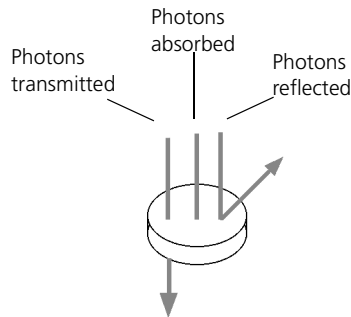

Even though an optical filter is rated at its 50% transmission point, the filter passes (lets through) a minimal amount of light outside of this indicated rating.

The slope of an optical filter transmission curve indicates filter performance. A relatively steep slope indicates a high-performance, high-quality optical filter that provides deep attenuation of out-of-band wavelengths. A less steep slope indicates that more light outside the rated bandwidth is being transmitted.

Types of optical filters

There are four types of filters.

- **Longpass (LP) filters.** Transmit wavelengths that are longer than the specified value.
- **Shortpass (SP) filters.** Transmit wavelengths that are shorter than the specified value. This type of filter is not recommended, but can be used in some custom configurations. See [Shortpass \(SP\) filters on page 105](#).
- **Bandpass (BP) filters.** Pass a narrow spectral band of light by combining the characteristics of shortpass filters, longpass filters, and absorbing layers.

- **Notch filters.** Pass all frequencies except those in a stop band centered on a center frequency. They are the opposite of bandpass filters.

The LSRFortessa uses LP filters and BP filters. Notch filters are sometimes used in special order BD LSRFortessa instruments.

Longpass (LP) filters

LP filters pass wavelengths longer than the filter rating. For example, a 500-LP filter permits wavelengths 500 nm or longer to pass through it and either absorbs or reflects wavelengths shorter than 500 nm.

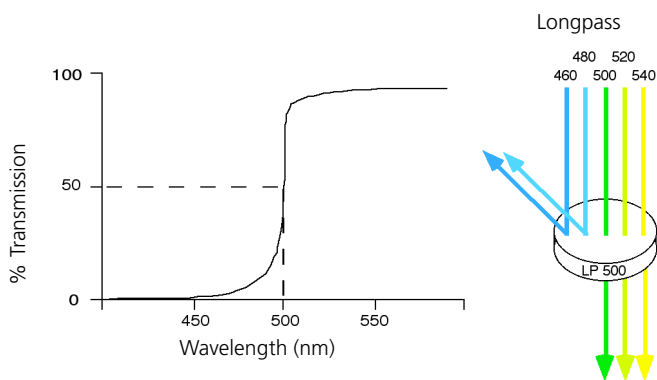

Shortpass (SP) filters

An SP filter has the opposite properties of an LP filter. An SP filter passes light with a shorter wavelength than the filter rating. For example, a 500-SP filter passes wavelengths of 500 nm or shorter, and reflects or absorbs wavelengths longer than 500 nm.

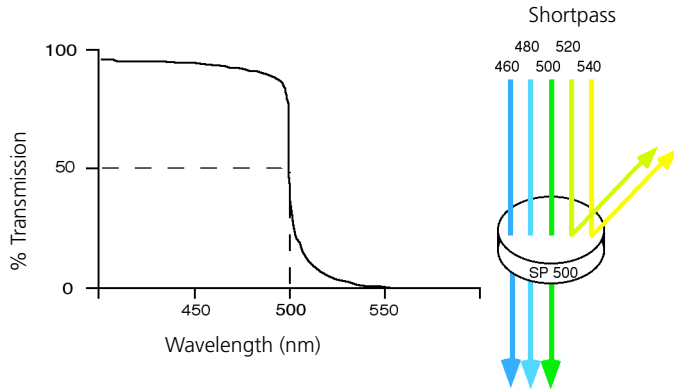

Bandpass (BP) filters

A BP filter transmits a relatively narrow range or band of light. BP filters are typically designated by two numbers. The first number indicates the center wavelength and the second refers to the width of the band of light that is passed. For example, a 500/50-BP filter transmits light that is centered at 500 nm and has a total bandwidth of 50 nm. Therefore, this filter transmits light between 475 and 525 nm.

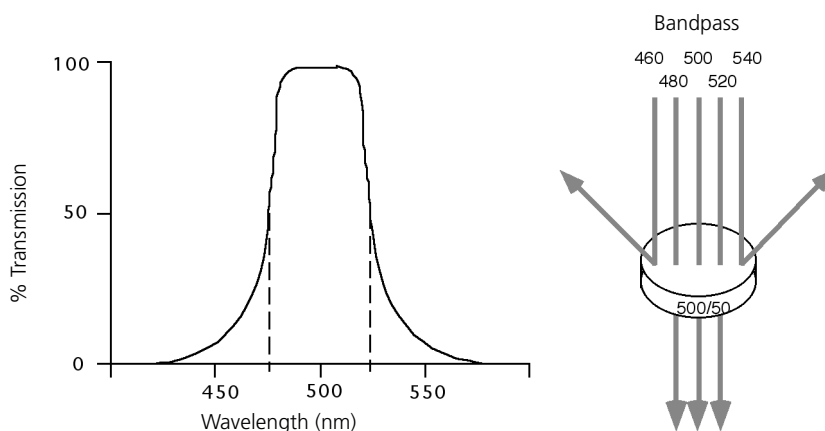

The performance of an optical BP filter depends on the optical transmission. Sample transmission curves are shown in the following figure. A filter with a narrower (steeper) transmission curve generally yields higher performance. The transmission specifications depend on the construction of the filter.

Higher performance filters generally have multiple layers of optical coatings and unique manufacturing processes. For more demanding multicolor applications, higher performance filters are available through the Special Order Research Program. Contact your local BD Biosciences sales representative for details.

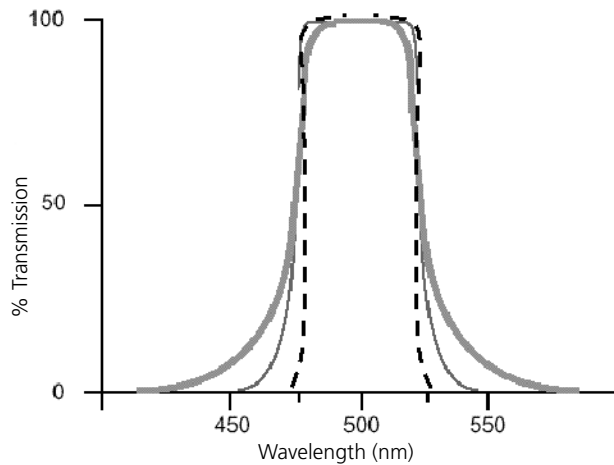

Dichroic mirrors

Dichroic filters that are used to direct different color light signals to different detectors are called dichroic mirrors.

Although some of the properties of LP and SP filters are similar to dichroic mirrors (for example, allowing a specific wavelength range to pass), filters and mirrors cannot be used interchangeably, especially if used as dichroic mirrors. A dichroic mirror must have a surface coating that reflects certain wavelengths, but many LP or SP filters are absorbance filters that do not have any specific reflective characteristics. Also, optical filters and dichroic mirrors are rated at a specific angle of incidence. When used in front of the fluorescence detectors, they are perpendicular to the incident light, and when used as a dichroic mirror, they are placed at an angle relative to the light source. Their optical properties are therefore designed for that angle of incidence.

Compensation theory

Fluorochromes emit light over a range of wavelengths. Optical filters are used to limit the range of frequencies measured by a given detector. However, when two or more fluorochromes are used, the overlap in wavelength ranges often makes it impossible for optical filters to isolate light from a given fluorochrome. As a result, light emitted from one fluorochrome appears in a detector intended for another. This is referred to as spillover. Spillover can be corrected mathematically by using a method called compensation.

In the following example, FITC emission appears primarily in the FITC detector, but some of its fluorescence spills over into the PE detector. The spillover must be corrected or compensated for. Alternatively, the spillover can be minimized by discrete excitation of fluorochromes. In the following example, excitation with a 561-nm laser (special order) will help minimize spillover.

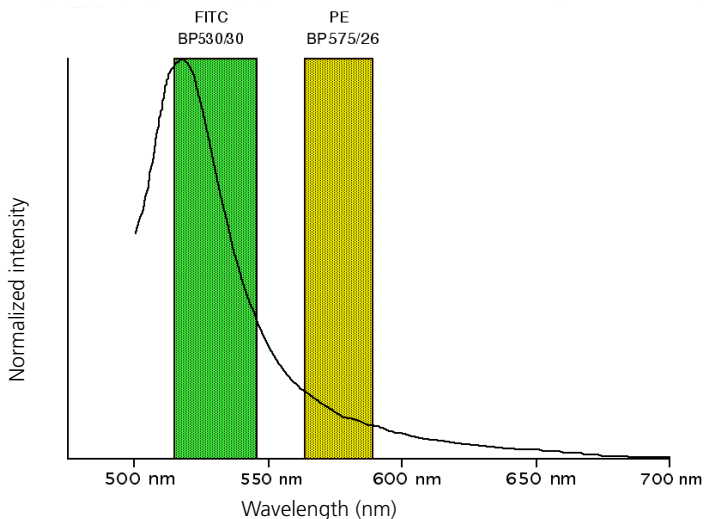

This spillover can be seen in a dot plot of FITC vs PE. The FITC spillover in the PE detector must be corrected as demonstrated in the two figures that follow.

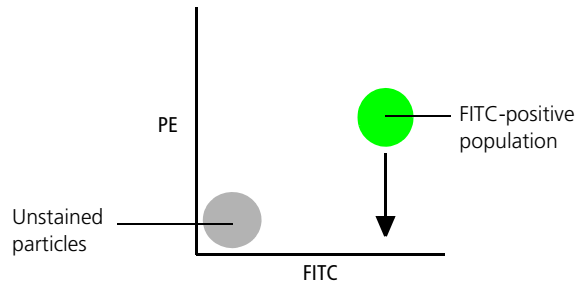

Using the **Compensation** tab of the **Cytometer** window in BD FACSDiva software, you can adjust the PE-%FITC spectral overlap value. Compensation is optimal when the positive and negative FITC populations have the same means in the PE parameter statistics.

The following image shows the FITC spillover optimally compensated out of the PE parameter.

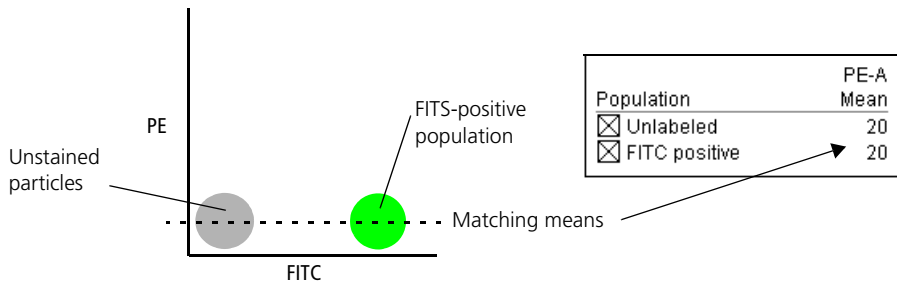

Once fluorescence compensation has been set for any sample, the compensation setting remains valid for a subsequent dim or bright sample (provided the signal is not saturated), because compensation subtracts a percentage of the fluorescence intensity. The following figure illustrates this principle. Although the signals differ in intensity, the percentage of the FITC spillover into the PE detector remains constant.

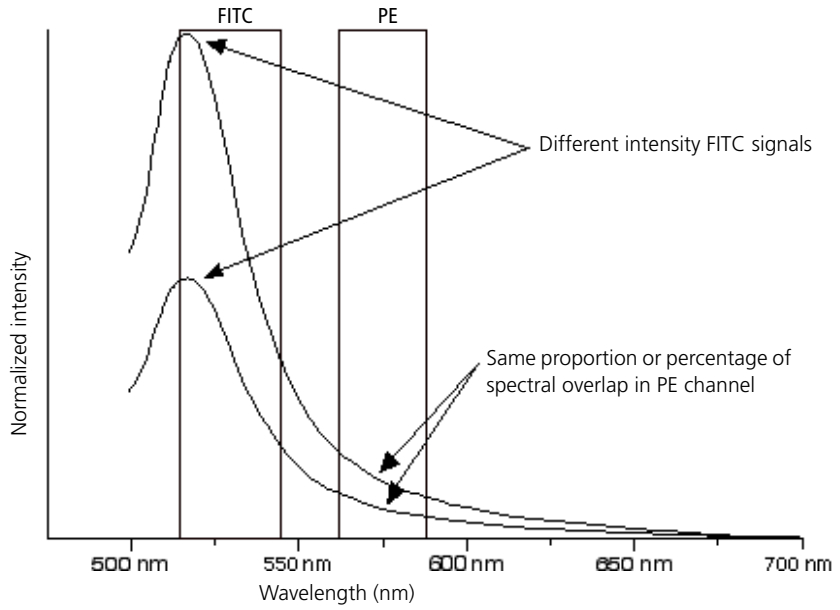

About electronics

About this topic

This topic describes the electronics in the BD LSRFortessa flow cytometer.

Pulse

As cells or other particles pass through a focused laser beam, they scatter the laser light and can emit fluorescence. Because the laser beam is focused on a small spot and particles move rapidly through the flow cell, the scatter or fluorescence emission signal has a very brief duration—only a few microseconds. This brief flash of light is converted into an electrical signal by the detectors. The electrical signal is called a pulse. The following figure illustrates the anatomy of a pulse.

1. A pulse begins when a particle enters the laser beam. At this point, both the beam intensity and signal intensity are low.

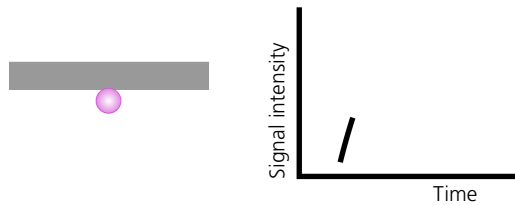

2. The pulse reaches a maximum intensity or height when the particle reaches the middle of the beam, where the beam and signal intensity are the brightest. The peak intensity, or height of the pulse, is measured at this point.

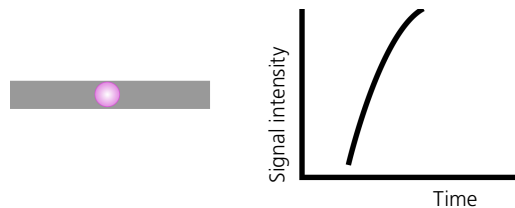

- As the particle leaves the beam, the pulse trails off below the threshold.

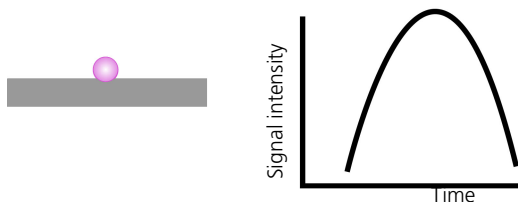

Pulse measurements

The pulse processors measure pulses by three characteristics: height, area, and width.

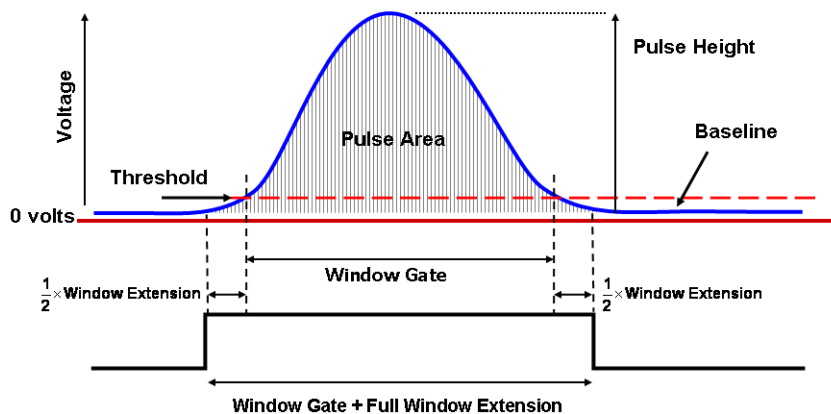

- **Height.** The maximum digitized intensity measured for the pulse.
- **Area.** The integration of all the digitized samples over time, where time is the window gate plus 1/2 the window extension added before the initial threshold, plus the other half of the window extension value added after the pulse drops below threshold.
- **Width.** Calculates: $\frac{\text{Area}}{\text{Height}} \times 64,000$

Digital electronics

BD LSRFortessa electronics digitize the signal intensity produced by a detector. The digitized data is stored in memory and further processed by the electronics to calculate:

- Pulse height, area, and width
- Compensation
- Parameter ratios

These results are transferred to your workstation computer for further processing by BD FACSDiva software. For more information about digital theory, see Digital Theory in the *BD FACSDiva Software Reference Manual*.

Threshold

The threshold is the level at which the system starts to measure signal pulses. A threshold is defined for a specific detector signal. The system continuously samples the digitized signal data and calculates pulse area, height, and width for all channels based on the time interval during which the threshold is exceeded.

Thresholds can also be set for more than one parameter, and pulse measures are based on either of the following:

- Intervals during which ALL signals exceed their threshold value
- Intervals during which ANY signal exceeds its threshold value

Laser controls

Controls in the **Laser** tab of the **Cytometer** window are used to manually set the (laser) delay, area scaling, and window extension values.

These parameters are set by BD Biosciences service personnel during instrument installation and performance check and are updated each time you run a performance check.

If needed, see [Optimizing laser delay \(page 165\)](#) for instructions on manually adjusting laser delay settings. Do not otherwise change the settings in the **Laser** tab unless instructed to do so by BD Biosciences. Changing the settings affects your data.

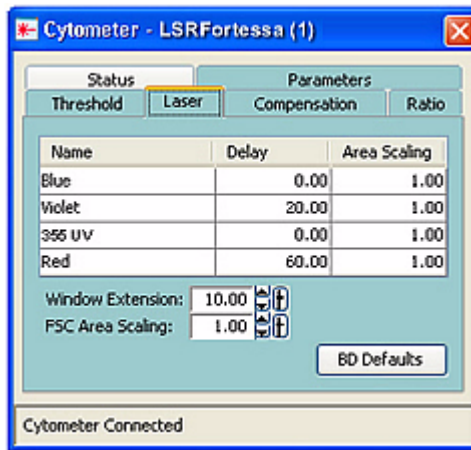

Related topics

- [Running a performance check \(page 64\)](#)
- [Optimizing laser delay \(page 165\)](#)

8

Troubleshooting

This chapter covers the following topics:

- [Cytometer troubleshooting \(page 116\)](#)
- [Electronics troubleshooting \(page 127\)](#)

Cytometer troubleshooting

About this topic

This topic describes possible problems and recommended solutions for BD LSRFortessa cytometer issues.

Droplets are visible on the SIP

Possible causes	Recommended solutions
Worn O-ring in retainer	Replace the O-ring. See Changing the sample tube O-ring (page 54) .
Outer sleeve is not seated in the retainer	<ol style="list-style-type: none"> 1. Loosen the retainer. 2. Push the outer sleeve up into the retainer until seated. 3. Tighten the retainer.
Outer sleeve is not on the sample injection tube	<p>Replace the outer sleeve.</p> <ol style="list-style-type: none"> 1. Loosen the retainer. 2. Slide the outer sleeve over the sample injection tube until it is seated. 3. Tighten the retainer.
Waste line is pinched, preventing proper aspiration	Check the waste line.
Waste tank is full	Empty the waste tank.
Droplet containment vacuum not functioning	Call your BD service representative.
The HTS acquisition control switch is in plate mode	Change the acquisition control switch to tube mode. See the <i>BD High Throughput Sampler User's Guide</i> for more information.

Sample tube not fitting on SIP

Possible causes	Recommended solutions
Sample tube other than BD Falcon® tubes used	Use BD Falcon 12 x 75-mm sample tubes. See Equipment on page 179 .
Worn Bal seal	Replace the Bal seal. See Changing the Bal seal on page 52 .
Sample tube is cracked	Transfer contents to a new tube.

Rapid sample aspiration

Possible causes	Recommended solutions
Support arm is to the side	Place the support arm under the sample tube.
Droplet containment module is failing	Try the solutions in Droplets are visible on the SIP (page 116) . If the issue is not resolved, call your BD service representative.

No events in acquisition display and RUN button is green

Possible causes	Recommended solutions
Threshold is not set to the correct parameter (usually FSC)	Set the threshold to the correct parameter for your application.
Threshold level is too high	Lower the threshold level.
PMT voltage for threshold parameter is set too low	Set the PMT voltage higher for the threshold parameter.
Gating issue	See the <i>BD FACSDiva Software Reference Manual</i> for information on setting gates.
Air in the sheath filter	Purge the filter. See Removing air bubbles on page 28 .

Possible causes	Recommended solutions
Air bubble or debris in flow cell	Prime the fluidics system. See Priming the fluidics on page 33 .
No sample in the tube	Verify that sample remains in the tube and if necessary, add sample to the tube or install a new sample tube.
Sample is not mixed properly	Mix the sample to suspend the cells.
Waste tank is full	Empty the waste tank.
PMT voltages set too low or too high for display parameter	Adjust the PMT voltages.
Too few events are displayed	Increase the number of events to display.
Sample injection tube is clogged	Remove the sample tube to allow backflushing. If the event rate is still erratic, clean the sample injection tube. See Cleaning the fluidics on page 41 .
Bal seal is worn	Replace the Bal seal. See Changing the Bal seal on page 52 .
Instrument is not warmed up	Wait 30 minutes for the instrument to warm up.

Possible causes	Recommended solutions
Laser delay is set incorrectly	Adjust the laser delay settings. See Manual settings on page 163 .
Laser is not functioning	Verify the malfunction by changing the threshold to an alternative laser while running the appropriate sample. If unsuccessful, contact BD Biosciences.
Tube is cracked or misshapen	Replace the sample tube.

No events in acquisition display and RUN button is orange

Possible causes	Recommended solutions
RUN is not activated	Press the RUN button.
Sample tube is not installed or is not properly seated	Install the sample tube correctly on the SIP.
Waste container is pressurized	<p>Replace the waste air filter.</p> <p> Caution! Pressurized contents might spray. Use appropriate cautionary measures.</p> <ol style="list-style-type: none"> 1. Slowly loosen the waste tank cap to relieve the pressure in the waste tank. 2. Remove the waste vent filter by rotating counter-clockwise. 3. Install a new waste vent filter.
Sample tube is cracked	Replace the sample tube.
Waste tubing line is not connected to the waste cap	Connect the waste tubing line to the waste cap.

Possible causes	Recommended solutions
Sheath container is not pressurized	<ul style="list-style-type: none"> Ensure that the sheath container lid and all connectors are securely seated. Inspect the sheath container O-ring inside the lid and replace it if necessary.
Bal seal is worn	Replace the Bal seal. See Changing the Bal seal on page 52 .
Air leak at sheath container	Ensure that the sheath container lid and all connectors are securely seated.
Sheath container is empty	Fill the sheath container.
Air in sheath filter	Purge the filter. See Removing air bubbles on page 28 .

No fluorescence signal

Possible causes	Recommended solutions
Incorrect fluorochrome assignment	Make sure that the cytometer configuration in the software matches the optical filters in the cytometer and the configuration is as expected.
Wrong filter is installed	Make sure the appropriate filter is installed for each fluorochrome. See Changing optical filters and mirrors on page 36 .
Laser is not functioning	Call your BD service representative.

No signal in red laser channels

Possible causes	Recommended solutions
Incorrect laser delays due to a change in the sheath tank fluid level	<ul style="list-style-type: none"> • Check the fluid level in the sheath tank and refill if necessary. • Adjust the laser delay settings. See Manual settings on page 163.

High event rate

Possible causes	Recommended solutions
Air bubbles in the sheath filter or flow cell	Remove the air bubbles. See Removing air bubbles on page 28 .
Threshold level is too low	Increase the threshold level. See the <i>BD FACSDiva Software Reference Manual</i> for instructions.
PMT voltage for the threshold parameter is set too high	Set the PMT voltage lower for the threshold parameter. See the <i>BD FACSDiva Software Reference Manual</i> for instructions.
Sample is too concentrated	Dilute the sample.
Sample flow rate is set to HI	Set the sample flow rate to MED or LO.

Low event rate

Possible causes	Recommended solutions
Threshold level is too high	Lower the threshold level. See the <i>BD FACSDiva Software Reference Manual</i> for instructions.
Air bubble or debris in the flow cell	Prime the fluidics system. See Priming the fluidics on page 33 .
PMT voltage for the threshold parameter is set too low	Set the PMT voltage higher for the threshold parameter. See the <i>BD FACSDiva Software Reference Manual</i> for instructions.
Sample is not adequately mixed	Mix the sample to suspend the cells.
Sample is too diluted	Concentrate the sample. If the flow rate setting is not critical to the application, set the flow rate switch to MED or HI.
Sample injection tube is clogged	Remove the sample tube to allow backflushing. If the event rate is still erratic, clean the sample injection tube. See Cleaning the fluidics on page 41 .

Erratic event rate

Possible causes	Recommended solutions
Sample tube is cracked	Replace the sample tube.
Air bubble or debris in the flow cell	Prime the fluidics system. See Priming the fluidics on page 33 .
Bal seal is worn	Replace the Bal seal. See Changing the Bal seal on page 52 .
Sample injection tube is clogged	Remove the sample tube to allow backflushing. If the event rate is still erratic, clean the sample injection tube. See Cleaning the fluidics on page 41 .
Contaminated sample	Prepare the specimen again. Ensure that the tube is clean.
Sheath filter is dirty	Replace the filter. See Changing the sheath filter on page 50 .

Distorted scatter parameters

Possible causes	Recommended solutions
Cytometer settings are improperly adjusted	Optimize the scatter parameters. See the <i>BD FACSDiva Software Reference Manual</i> for instructions.
Air bubble in sheath filter or flow cell	Purge the air from the filter. See Removing air bubbles on page 28 .

Possible causes	Recommended solutions
Flow cell is dirty	Flush the system. See Flushing the system on page 44 .
Air leak at sheath container	Ensure that the sheath container lid is tight and all connectors are secure.
Hypertonic buffers or fixative	Replace the buffers or fixative.

Excessive amount of debris in display

Possible causes	Recommended solutions
Threshold level is too low	Increase the threshold level.
Sheath filter is dirty	Replace the filter. See Changing the sheath filter on page 50 .
Flow cell is dirty	Flush the system. See Flushing the system on page 44 .
Dead cells or debris in sample	Examine the sample under a microscope.
Sample is contaminated	Re-stain the sample. Ensure that the tube is clean.
Stock sheath fluid is contaminated	Rinse the sheath container with DI water, then fill the container with sheath fluid from another (or new lot) bulk container.

High CV or Poor QC results

Possible causes	Recommended solutions
Air bubble in sheath filter or flow cell	<ul style="list-style-type: none"> • Purge the filter. See Removing air bubbles on page 28. • Prime the fluidics system. See Priming the fluidics on page 33.
Sample flow rate is set too high	Set the sample flow rate lower.
Air leak at sheath container	Ensure that the sheath container lid is tight and all connectors are secure.
Flow cell is dirty	Flush the system. See Flushing the system on page 44 .
The dichroic mirrors are installed backwards	Remove the dichroic mirrors, reverse them, and replace them in the optical slot.
Waste tank is pressurized	<p>Replace the waste vent filter.</p> <p> Caution! Pressurized contents might spray. Use appropriate cautionary measures.</p> <ol style="list-style-type: none"> 1. Slowly loosen the waste tank cap to relieve the pressure in the waste tank. 2. Remove the waste vent filter by rotating counter-clockwise. 3. Install a new waste vent filter.
Poor sample preparation	Repeat sample preparation.

Possible causes	Recommended solutions
Sample not diluted in same fluid as sheath fluid	Dilute the sample in the same fluid as you are using for sheath.
Optical filters are incorrect	Check the configuration and insert the correct filters.
Old or contaminated QC particles	Make new QC samples and perform the quality control procedure again.
Instrument is not warmed up	Wait 30 minutes for the instrument to warm up.
Laser not functioning	Contact BD Biosciences.
Optical alignment problem	Contact BD Biosciences.
Optical filters are incorrect	Check the configuration and insert the correct filters.

Electronics troubleshooting

About this topic

This topic describes possible problems and recommended solutions for BD LSRFortessa electronic issues.

“Cytometer Disconnected” in cytometer window

Possible causes	Recommended solutions
Cytometer power is off	Turn on the cytometer main power.
Communication failure between workstation and cytometer	<ul style="list-style-type: none"> • In BD FACSDiva software, select Cytometer > Connect. • If connecting does not work, restart the cytometer. Turn the cytometer off, wait 1 minute, and turn on the cytometer main power. • If connecting still does not work, contact BD Biosciences.

Need more information fast?

Information about this product is also available in your software's Help system.

You can keep the Help window open while you use the software or print the information directly from the window.

Internet access is not required to use the Help system.

9

Detector array configurations

This chapter covers the following topics:

- [Fluorescence spectra \(page 130\)](#)
- [About configuration maps \(page 132\)](#)
- [About the base configuration \(page 133\)](#)
- [Base configuration octagon and trigon maps \(page 138\)](#)
- [Special Order configurations \(page 149\)](#)

Fluorescence spectra

About this topic

This topic shows sample emission spectra from common fluorochromes, as well as the more common laser excitation lines. This information is useful for designing multicolor panels. An interactive fluorescence viewer is also available at bdbiosciences.com/colors/fluorescence_spectrum_viewer.

Designing multicolor panels

The BD LSRFortessa cytometer is designed specifically for multicolor research. There are many options for dyes, reagents, and system configurations.

When choosing a configuration or panel, it is important to remember that final results depend on the excitation and emission spectra of the individual dye, the number of fluorescently labeled binding sites on the cell, as well as spectral overlap and spillover to other PMTs. For more information about designing multicolor panels, see *Selecting Reagents for Multicolor Flow Cytometry* (Part No. 23-9538-02).

Example laser and dye interactions

The following figure shows the emission spectra of some common dyes, based on laser excitation. In many cases, a given dye can be excited by multiple laser wavelengths, yielding different emission intensities.

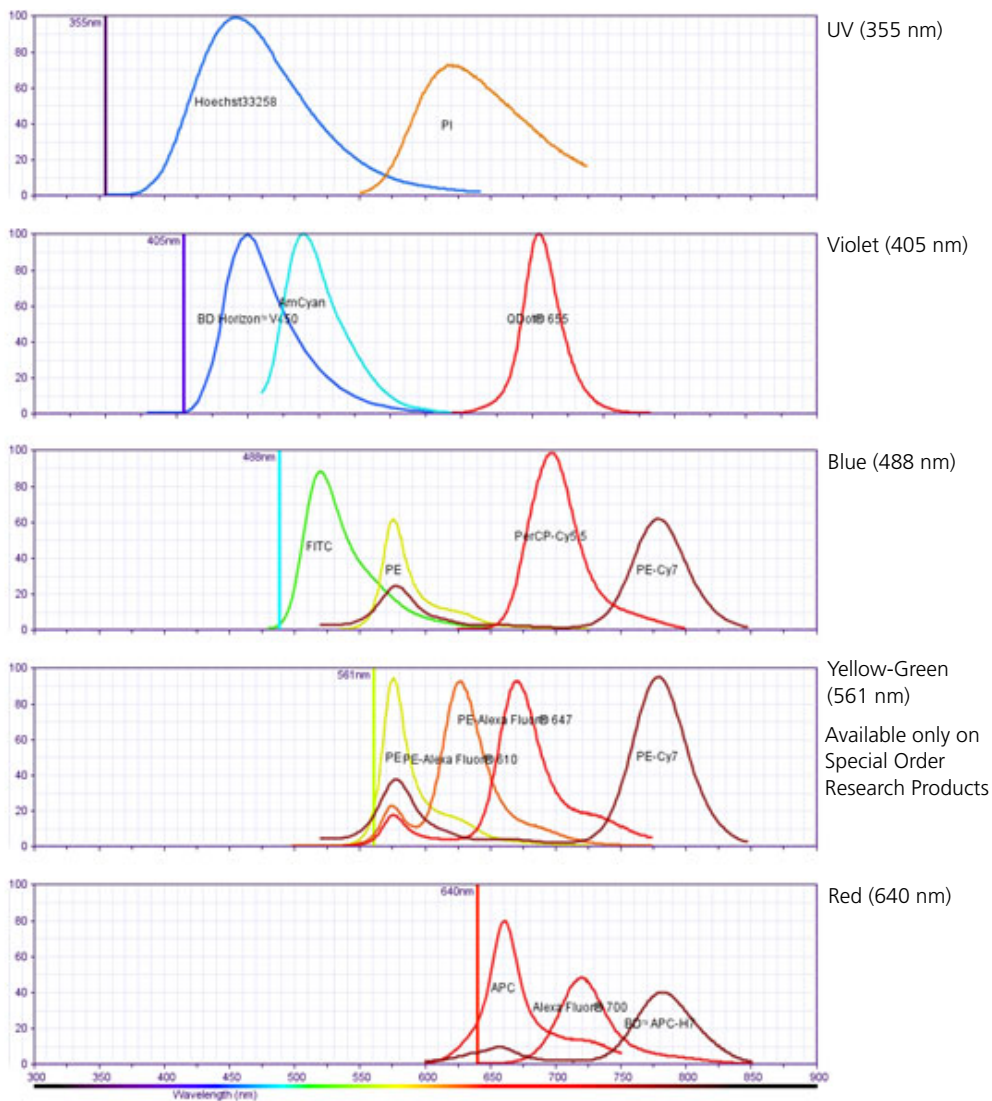

About configuration maps

About this topic

This topic describes the filter and mirror arrangements in the detector arrays.

Filter and mirror arrangement

The filters are arranged in the detector array to steer progressively shorter wavelengths of light to the next PMT in the array. The longest wavelength should be in the A position and the shortest wavelength should be in the last position used.

There should not be any empty slots for any laser being used. Always use a blank optic holder.

If a slot is filled with a filter or mirror, an identifying number appears in that position on the configuration map. If a slot is filled with a blank optic holder, that position on the configuration map is unlabeled.

About the base configuration

About this topic

This section describes the base configuration options available with the BD LSRFortessa.

Nine available configurations

The base configuration for a BD LSRFortessa cytometer supports detectors, filters, and mirrors for up to four lasers to provide up to 18-color detection.

Number of lasers	Colors	Lasers	See section...
1	4	4 Blue	Four-color blue laser configuration (page 139)
2	6	4 Blue	Four-color blue laser configuration (page 139)
		2 Red	Two-color red trigon configuration (page 142)
	7	5 Blue	Five-color blue laser configuration (page 140)
		2 UV	Two-color UV laser configuration (page 148)
	8	5 Blue	Five-color blue laser configuration (page 140)
		3 Red	Three-color red laser configuration (page 143)

Number of lasers	Colors	Lasers	See section...
3	8	4 Blue	Four-color blue laser configuration (page 139)
		2 Red	Two-color red trigon configuration (page 142)
		2 UV	Two-color UV laser configuration (page 148)
	8	4 Blue	Four-color blue laser configuration (page 139)
		2 Red	Two-color red trigon configuration (page 142)
		2 Violet	Two-color violet laser configuration (page 145)
	10	5 Blue	Five-color blue laser configuration (page 140)
		3 Red	Three-color red laser configuration (page 143)
		2 UV	Two-color UV laser configuration (page 148)
	11	5 Blue	Five-color blue laser configuration (page 140)
		3 Red	Three-color red laser configuration (page 143)
		3 Violet	Three-color violet laser configuration (page 146)
	14	5 Blue	Five-color blue laser configuration (page 140)
		3 Red	Three-color red laser configuration (page 143)
		6 Violet	Six-color violet octagon (page 147)

Number of lasers	Colors	Lasers	See section...
3	8	4 Blue	Four-color blue laser configuration (page 139)
		2 Red	Two-color red trigon configuration (page 142)
		2 UV	Two-color UV laser configuration (page 148)
	8	4 Blue	Four-color blue laser configuration (page 139)
		2 Red	Two-color red trigon configuration (page 142)
		2 Violet	Two-color violet laser configuration (page 145)
	10	5 Blue	Five-color blue laser configuration (page 140)
		3 Red	Three-color red laser configuration (page 143)
		2 UV	Two-color UV laser configuration (page 148)
	11	5 Blue	Five-color blue laser configuration (page 140)
		3 Red	Three-color red laser configuration (page 143)
		3 Violet	Three-color violet laser configuration (page 146)
	14	5 Blue	Five-color blue laser configuration (page 140)
		3 Red	Three-color red laser configuration (page 143)
		6 Violet	Six-color violet octagon (page 147)

Number of lasers	Colors	Lasers	See section...
4	10	4 Blue	Four-color blue laser configuration (page 139)
		2 Red	Two-color red trigon configuration (page 142)
		2 Violet	Two-color violet laser configuration (page 145)
		2 UV	Two-color UV laser configuration (page 148)
	13	5 Blue	Five-color blue laser configuration (page 140)
		3 Red	Three-color red laser configuration (page 143)
		3 Violet	Three-color violet laser configuration (page 146)
		2 UV	Two-color UV laser configuration (page 148)
	16	5 Blue	Five-color blue laser configuration (page 140)
		3 Red	Three-color red laser configuration (page 143)
		6 Violet	Six-color violet octagon (page 147)
		2 UV	Two-color UV laser configuration (page 148)
	18	6 Blue	Six-color blue laser configuration (page 141)
		4 Red	Four-color red laser configuration (page 144)
		6 Violet	Six-color violet octagon (page 147)
		2 UV	Two-color UV laser configuration (page 148)

Base configuration

The BD LSRFortessa has one base configuration at installation. Custom configurations can be added for different applications. The following image shows a default base cytometer configuration.

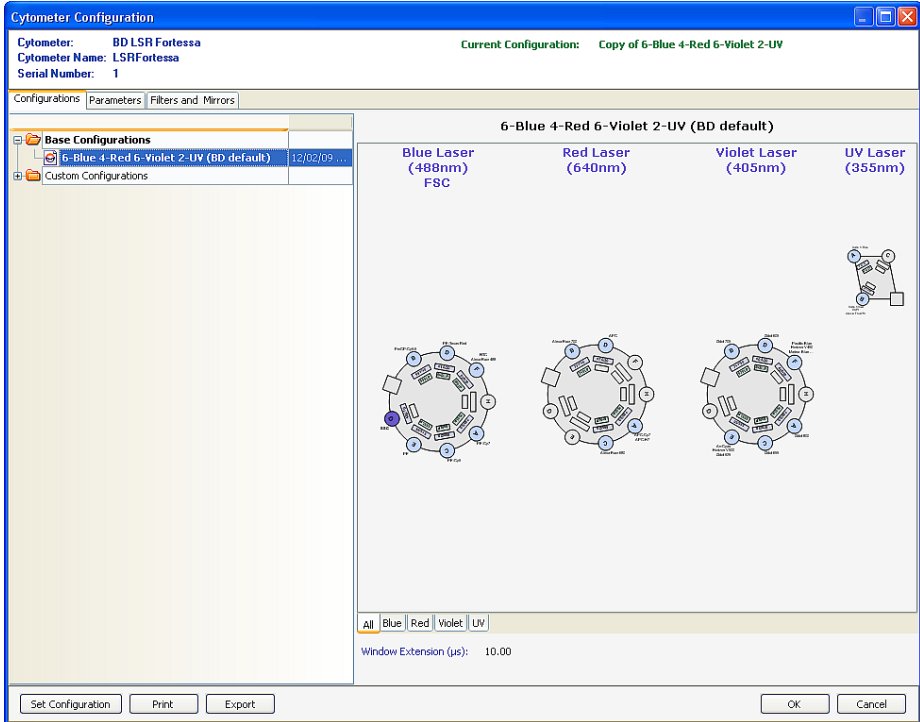

Upgrade options

The BD LSRFortessa cytometer optical configuration can be upgraded to use different special order wavelength options and a variety of detectors. See [Special Order configurations \(page 149\)](#) for a list of some common special order laser/detector combinations available through the BD Special Order Research Program. Many other special order configurations and options are also available.

Related topics

- [Verifying the configuration and user preferences \(page 61\)](#)
 - [Base configuration octagon and trigon maps \(page 138\)](#)
-

Base configuration octagon and trigon maps

About this topic

This section describes how filters and mirrors are arranged for standard trigon and octagon configurations.

About the maps

The tables in this section show the detectors, filters, and mirrors used in the each configuration, and recommended fluorochromes for each detector. The word “blank” indicates that a blank optical holder should be used instead of a mirror or filter. A dash (—) indicates that no slot exists for a mirror in that PMT position.

Four-color blue laser configuration

The following map shows the four-color configuration for the 488-nm blue laser.

PMT	LP mirror	BP filter	Fluorochromes
A	750	780/60	PE-Cy TM 7
B	685	695/40	PerCP-Cy5.5, PE-Cy TM 5, PerCP, PI
C	550	575/26	PE
D	505	530/30	FITC, Alexa Fluor [®] 488
E	Blank	488/10	SSC

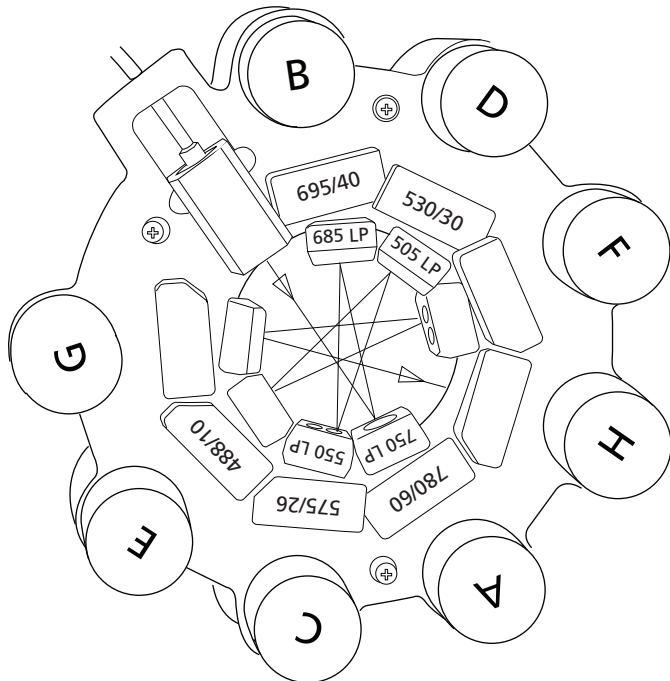

Five-color blue laser configuration

The following map shows the five-color configuration for the 488-nm blue laser.

PMT	LP mirror	BP filter	Fluorochromes
A	750	780/60	PE-Cy7
B	685	695/40	PerCP-Cy5.5
C	600	610/20	PE-Texas Red®
D	550	575/26	PE
E	505	530/30	FITC, Alexa Fluor® 488
F	Blank	488/10	SSC

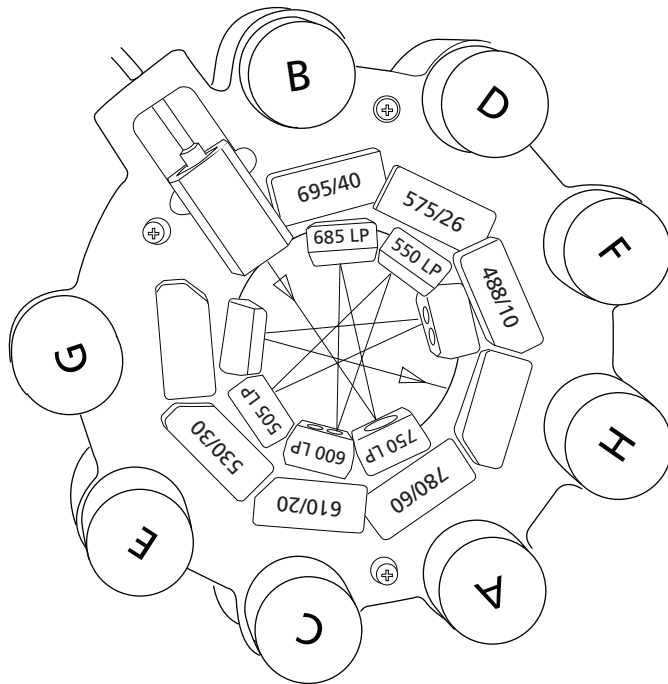

Six-color blue laser configuration

The following map shows the six-color configuration for the 488-nm blue laser.

PMT	LP mirror	BP filter	Fluorochromes
A	750	780/60	PE-Cy7
B	685	695/40	PerCP-Cy5.5
C	655	670/30	PE-Cy5
D	600	610/20	PE-Texas Red®
E	550	575/26	PE
F	505	530/30	FITC, Alexa Fluor® 488
G	Blank	488/10	SSC

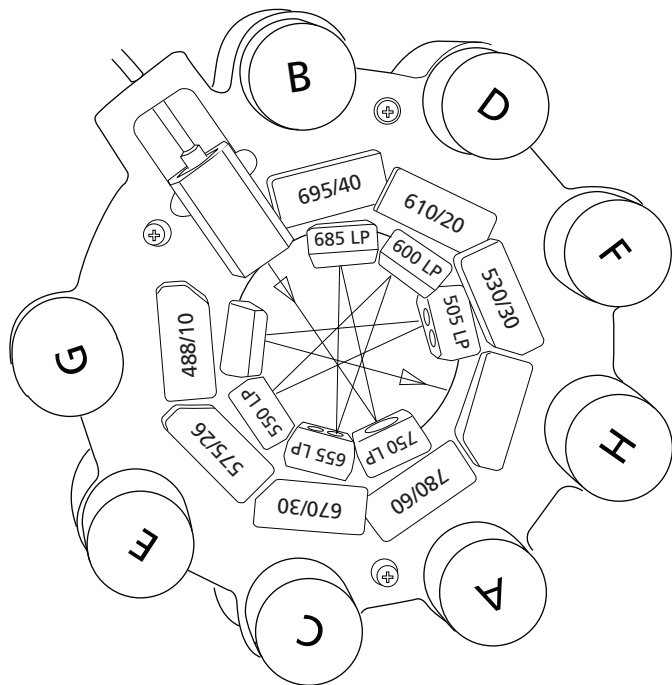

Two-color red trigon configuration

The following map shows the two-color configuration for the 640-nm red laser.

PMT	LP mirror	BP filter	Fluorochromes
A	750	780/60	APC-Cy7, APC-H7
B	Blank	670/14	APC

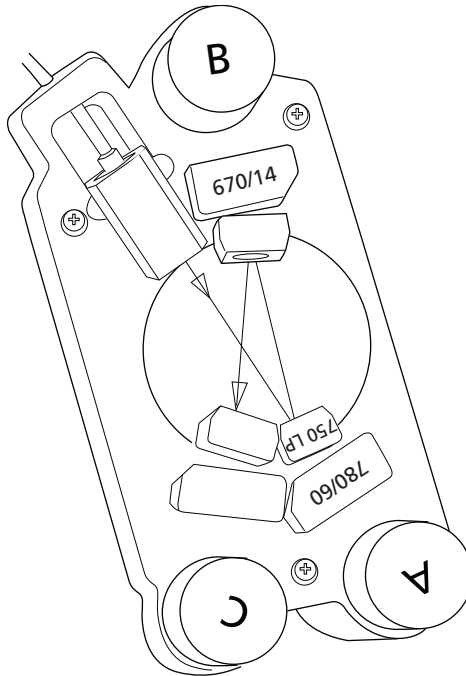

Three-color red laser configuration

The following map shows the three-color configuration for the 640-nm red laser.

PMT	LP mirror	BP filter	Fluorochromes
A	750	780/60	APC-Cy7, APC-H7
B	710	730/45	Alexa Fluor® 700
C	—	670/14	APC

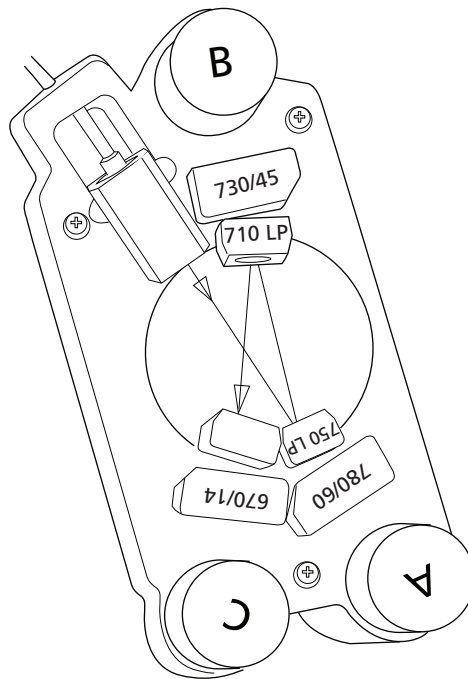

Four-color red laser configuration

The following map shows the four-color configuration for the 640-nm red laser.

PMT	LP mirror	BP filter	Fluorochromes
A	750	780/60	APC-Cy7, APC-H7
B	710	730/45	Alexa Fluor® 700
C	675	685/35	Alexa Fluor® 680
D	—	670/14	APC

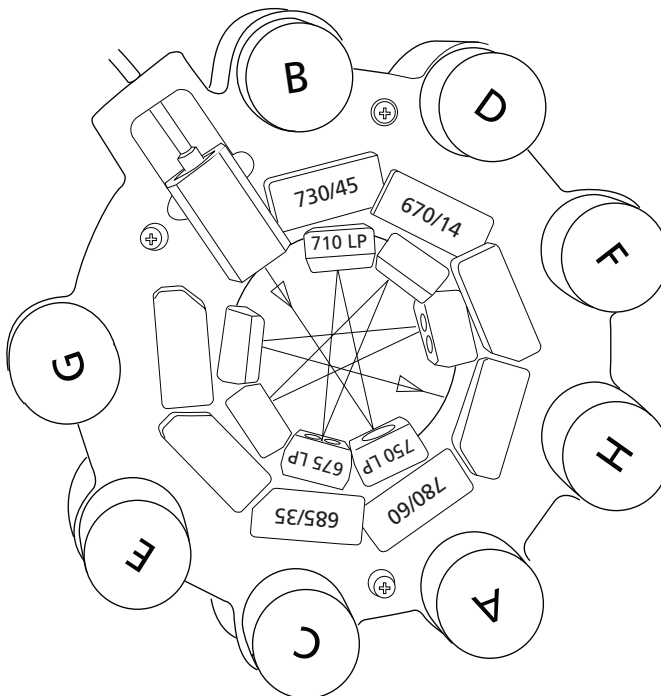

Two-color violet laser configuration

The following map shows the two-color configuration for the 405-nm violet laser.

PMT	LP mirror	BP filter	Fluorochromes
A	475	525/50	AmCyan, Qdot 525, BD Horizon™ V500
B	Blank	450/50	Pacific Blue™, BD Horizon™ V450, Marina Blue®, Alexa Fluor® 405

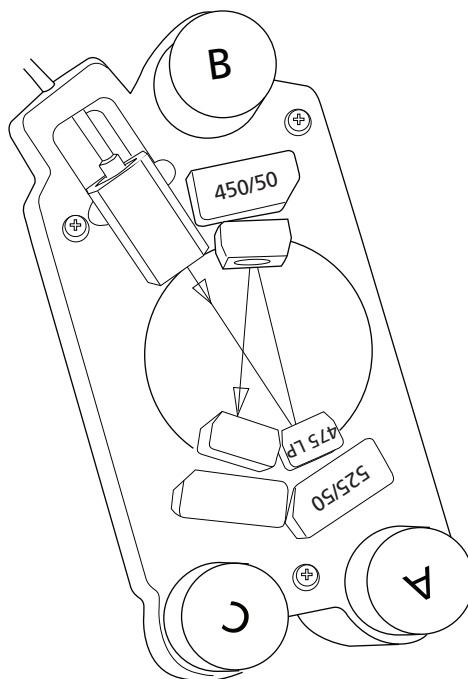

Three-color violet laser configuration

The following map shows the three-color configuration for the 405-nm violet laser.

PMT	LP mirror	BP filter	Fluorochromes
A	595	605/12	Qdot 605
B	475	525/50	AmCyan, V500, Qdot 525
C	—	450/50	Pacific Blue™, V450, Marina Blue®, Alexa Fluor® 405

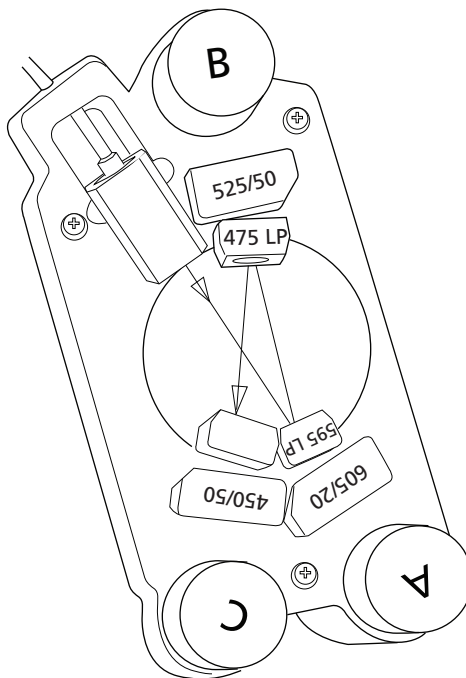

Six-color violet octagon

The following map shows the six-color configuration for the 405-nm violet laser.

PMT	LP mirror	BP filter	Fluorochromes
A	630	655/8	Qdot 655
B	595	605/12	Qdot 605
C	575	585/15	Qdot 585
D	545	560/20	Qdot 565
E	475	525/50	AmCyan, V500, Qdot 525
F	Blank	450/50	Pacific Blue™, V450, Marina Blue®, Alexa Fluor® 405

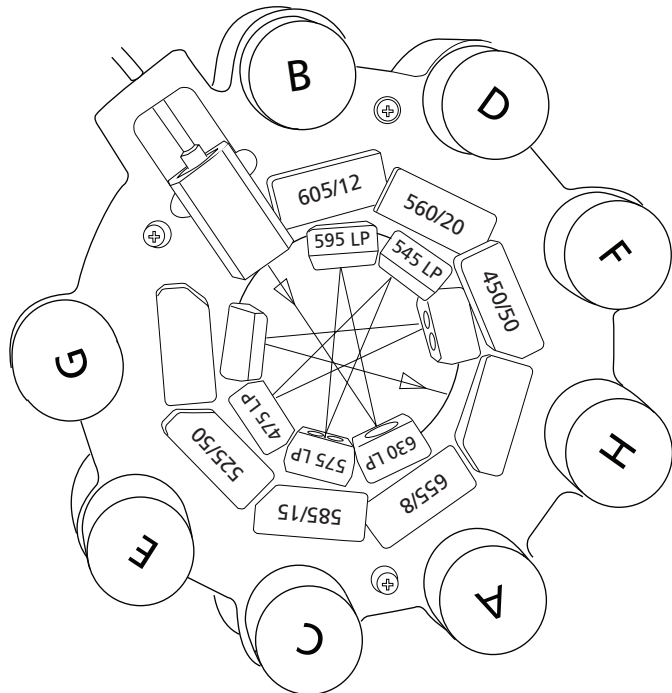

Two-color UV laser configuration

The following map shows the two-color configuration for the 355-nm UV laser.

PMT	LP mirror	BP filter	Fluorochromes
A	505	530/30	Indo-1 (Blue)
B	Blank	450/50	Indo-1 (Violet), DAPI, Alexa Fluor® 350

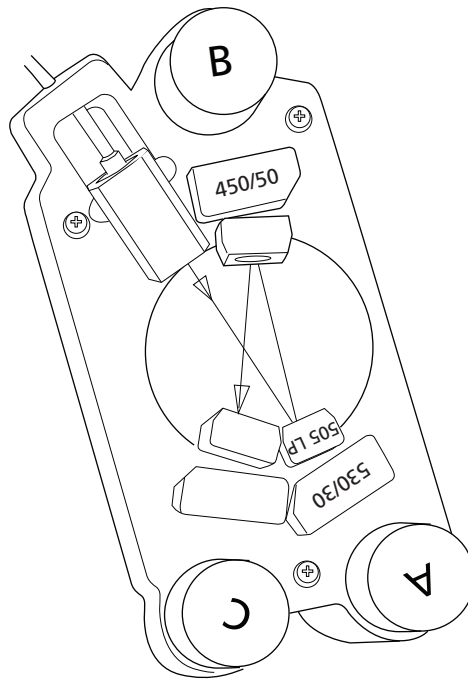
**Related topics**

- [About the base configuration \(page 133\)](#)
- [Special Order configurations \(page 149\)](#)

Special Order configurations

About this topic This topic describes some of the more common configurations available through the Special Order Research Program.

Available options The BD LSRFortessa cytometer can be configured with up to 5 lasers choosing from 11 different special order wavelength options and a variety of detectors. This section shows some of the common special order laser/detector combinations. Contact your local BD Biosciences sales representative for information about other configurations.

BP filters used with CS&T Not all combinations of Special Order BP filters and lasers are normalized to CS&T settings. In this case, CS&T will generate Qr and Br numbers that are not comparable from instrument to instrument. Care should be taken when interpreting the CS&T reported Qr values on Special Order BD LSRFortessa instruments. Please see the latest published filter guides available on our website (bdbiosciences.com) for more information.

Blue 488 nm (20–100 mW) The fluorochromes listed in the following table can be used with this laser wavelength for cell surface markers, live/dead discrimination, and cell cycle applications. See [Common blue laser configurations \(page 154\)](#) for common octagon and trigon configuration maps.

Fluorochromes	BP filters
SSC	488/10
FITC, Alexa Fluor® 488	530/30
PE	575/25 575/26 576/26 585/42

Fluorochromes	BP filters
PE-Texas Red®, PI	610/20 616/23
PE-Cy5	660/20 670/30
PerCP, PerCP-Cy5.5, PE-Cy5.5	670/14 675/20 695/40 710/50
PE-Cy7	780/60

Red 640 nm (40 mW)

The fluorochromes listed in the following table can be used with this laser wavelength for the cell surface marker application. See [Common red laser configurations \(page 156\)](#) for two common trigon configuration maps.

Fluorochromes	BP filters
APC, Alexa Fluor® 647	670/30
Alexa Fluor® 680	685/35
Alexa Fluor® 700	710/50 710/20 712/21 730/45
APC-Cy7, APC-H7	780/60

Violet 405 nm (20–100 mW)

The fluorochromes listed in the following table can be used with this laser wavelength for cell surface marker, live/dead discrimination, and cell cycle applications. See [Common violet laser configurations \(page 157\)](#) for common octagon and trigon configuration maps.

Fluorochromes	BP filters
V450, Pacific Blue™	450/50 450/40 450/20 440/40
AmCyan, Alexa Fluor® 430, V500, DAPI	510/50 525/50
Qdot 525	NA
Qdot 545	NA
Qdot 565	560/20
Qdot 585	585/15
Qdot 605	605/12 605/40
Qdot 655	655/8
Qdot 700	NA
Qdot 705	NA
Qdot 800	NA

UV 355 nm (20–100 mW)

The fluorochromes listed in the following table can be used with this laser wavelength for the cell cycle application with the DAPI and Hoechst fluorochromes. The wavelength is used for the Ca⁺² flux application with both Indo-1 fluorochromes. See [Common UV laser configurations \(page 159\)](#) for two common trigon configuration maps.

Fluorochromes	BP filters
DAPI, Hoechst	440/40 450/20 450/40 450/50
Indo-1 (Ca Bound)	450/50
Indo-1 (Ca unbound)	530/30

Yellow-Green 561 nm (50 mW)

The fluorochromes listed in the following table can be used with this laser wavelength for cell surface marker and fluorescent protein applications. See [Common yellow-green laser configuration \(page 161\)](#) for a common octagon configuration map.

Fluorochromes	BP filters
PE, DsRed	582/15 582/15
PE-Texas Red®, mCherry	610/20
PE-Cy5	660/20 670/30
PE-Cy5.5	710/50
PE-Cy7	780/60

Green 532 nm (150 mW)

The fluorochromes listed in the following table can be used with this laser wavelength for the cell surface markers application. See [Common green laser configuration \(page 162\)](#) for a common octagon configuration map.

Fluorochromes	BP filters
PE	575/25
PE-Texas Red®	610/20
PE-Cy5	660/20 670/30
PE-Cy5.5	695/40 710/50
PE-Cy7	780/60

Common blue laser configurations

The following maps show two common configurations for the 488-nm blue laser.

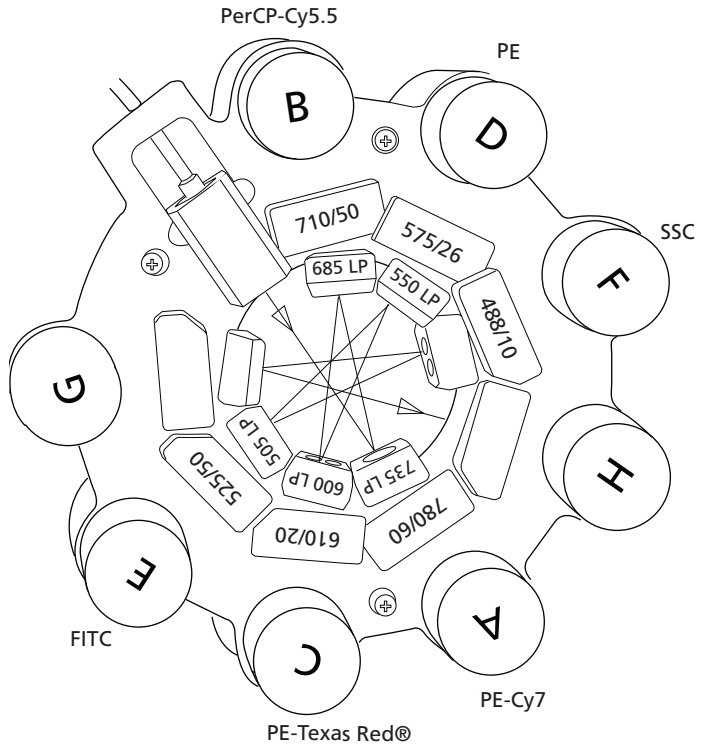

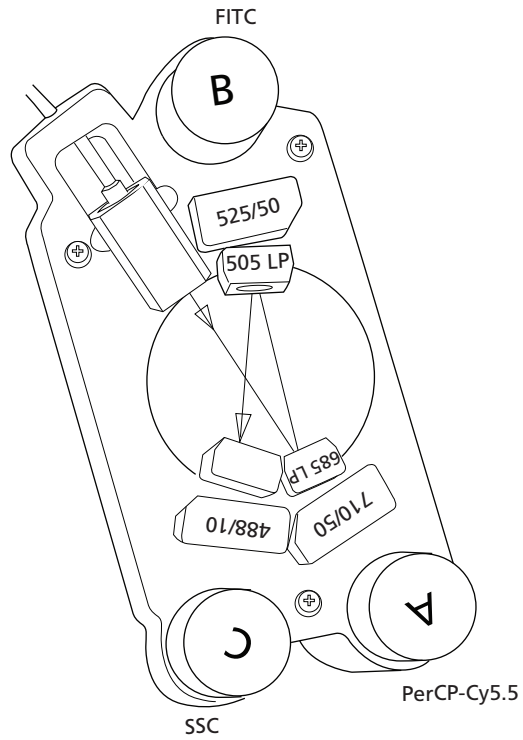

Note that with the 488-nm blue laser, FITC requires a 525/50 notch filter if the cytometer also uses a 532-nm laser.

Common red laser configurations

The following maps show two common configurations for the 640-nm red laser.

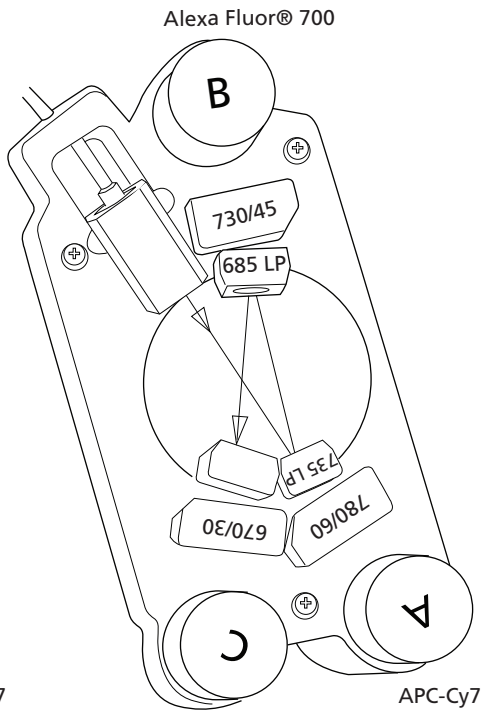
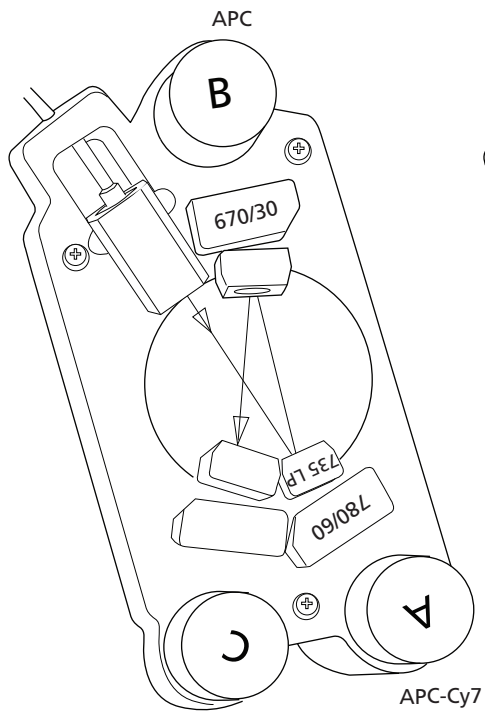

Common violet laser configurations

The following maps show two common configurations for the 405-nm violet laser.

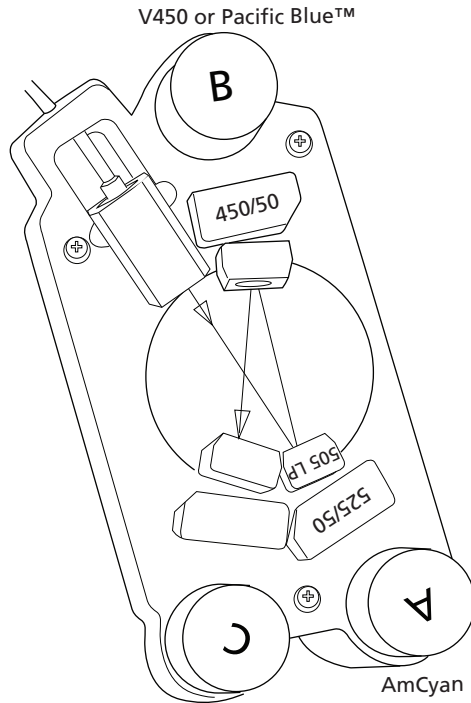

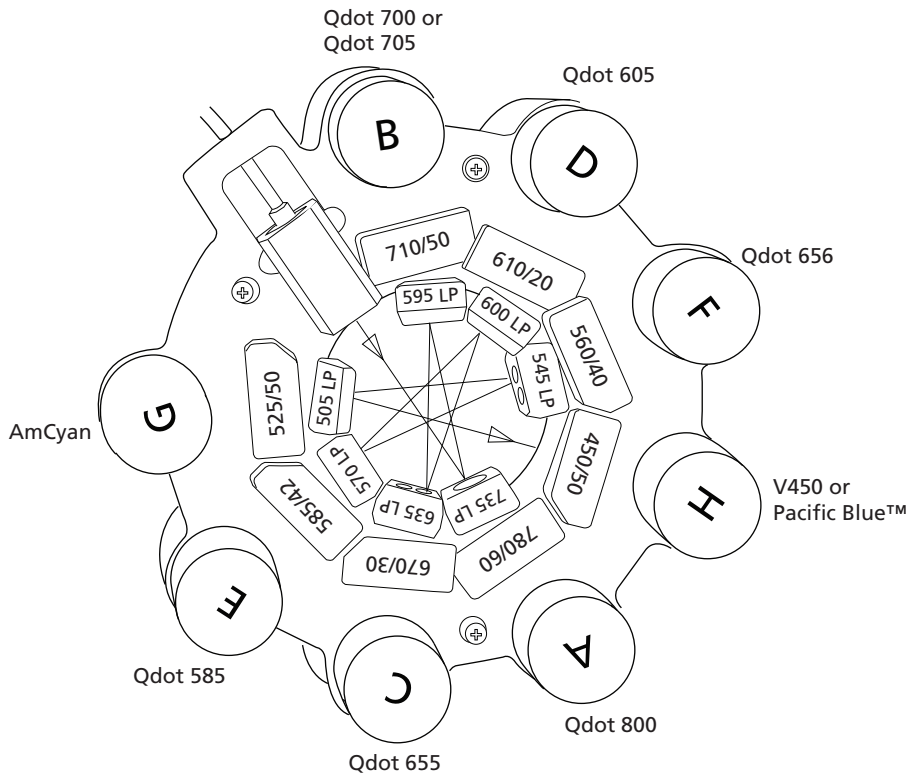

Common UV laser configurations

The following maps show two common configurations for the 355-nm UV laser.

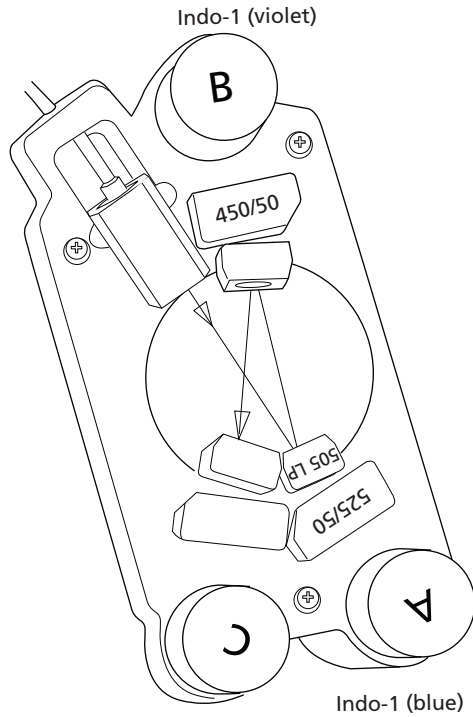

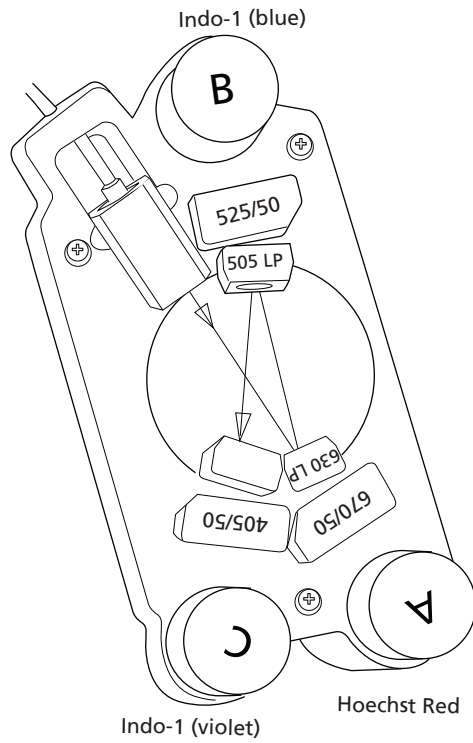

Common yellow-green laser configuration

The following map shows a common configuration for the 561-nm yellow-green laser.

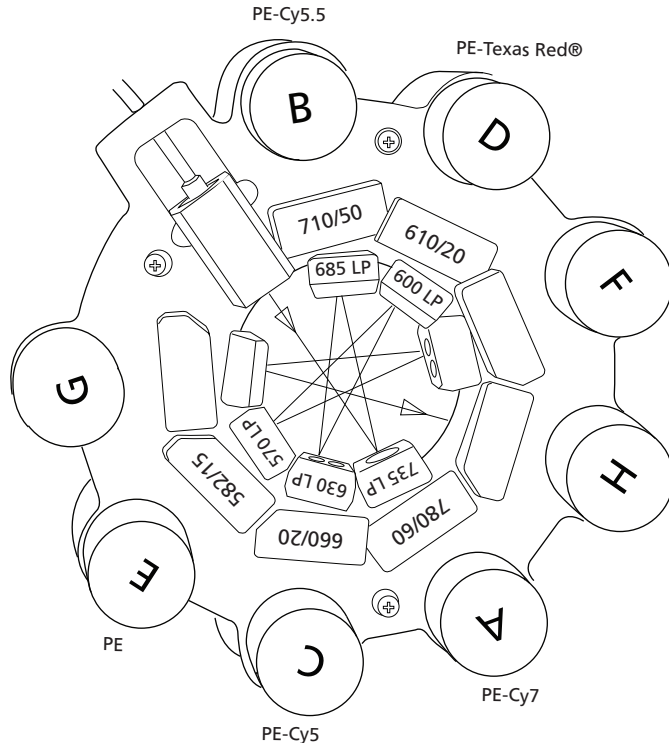

Note that when you use a PE conjugate with a 561-nm laser, you must replace the 585/42 bandpass filter (BP) with a 582/15 BP, regardless of which laser (blue, green, or yellow-green) is exciting the PE fluorochromes.

Common green laser configuration

The following map shows a common configuration for the 532-nm green laser.

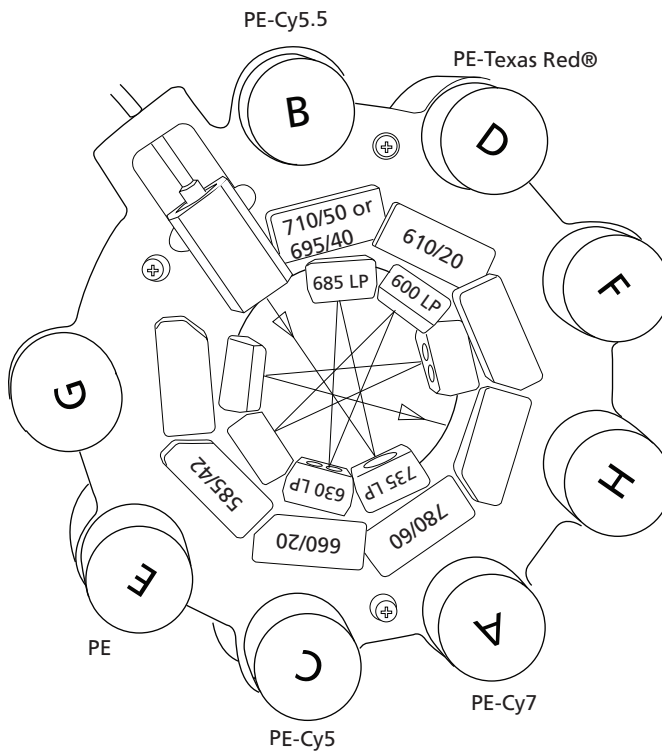

10

Manual settings

This section covers the following topics:

- [About laser delay \(page 164\)](#)
- [Optimizing laser delay \(page 165\)](#)
- [Adjusting area scaling \(page 168\)](#)

About laser delay

About this topic

This topic describes how to manually set the laser delay if you are not using Cytometer Setup and Tracking.

About laser signal delay

Sample interrogation takes place within the cuvette flow cell. Laser light is directed through a series of prisms that focus multiple lasers on the event stream at different positions. This allows optimal detection of fluorescent signals from each laser with minimal cross-contamination from the other beams.

For example, in a BD LSRFortessa four-laser system, the blue laser intercepts the stream first, followed by the violet, UV, and red lasers. Because the laser signals are spatially separated, there is a slight delay between the detection of each laser's signal.

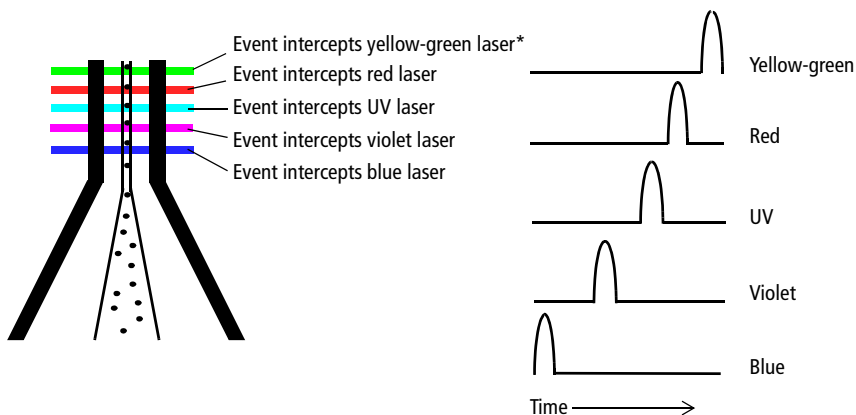

*The yellow-green laser is only available through the BD Special Order Research Program.

The laser delay setting in BD FACSDiva software is used to realign the signals so they can be measured and displayed on the same time scale. Signals are aligned with respect to the blue laser, so the blue laser will have a 0 delay value, and the red laser will have the longest delay.

Optimizing laser delay

About this topic

This topic describes how to optimize the laser delay using BD FACSDiva software.

Before you begin

To optimize the delay for a given laser, you must acquire events from a sample with a fluorescence signal excited by that laser. Follow the procedures in [Recording and analyzing data \(page 81\)](#), for sample optimization and acquiring data.

Procedure

To optimize laser delay:

1. While acquiring data from your sample, create a histogram to show the fluorescence signal excited by the laser for which the delay is to be optimized.
2. In the **Acquisition Dashboard**, set the **Events to Display** to *500* events.
3. Click the **Laser** tab in the **Cytometer** window.

Window extension and laser delay values are displayed in microseconds (μs).

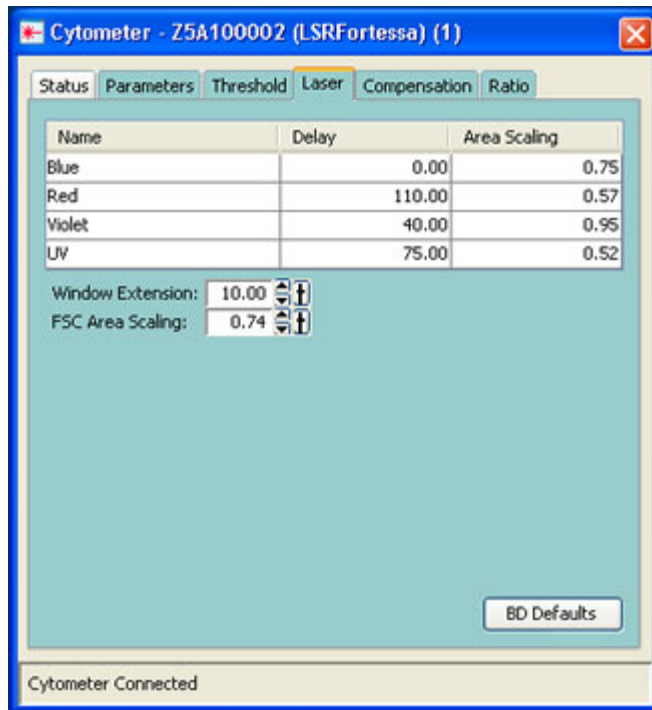

4. Set the **Window Extension** value to $0 \mu\text{s}$.
5. Set an initial laser delay value **only** for the laser you are optimizing.
 - If you are optimizing the violet laser, set its delay to $40 \mu\text{s}$.
 - If you are optimizing the UV laser, set its delay to $75 \mu\text{s}$.
 - If you are optimizing the red laser, set its delay to $110 \mu\text{s}$.

6. While observing the positive events on the histogram, adjust the laser delay in 1- μ s increments. You might need to adjust the delay above or below the initial setting.

Choose the setting that moves the events farthest to the right (highest fluorescence intensity).

7. Draw an interval gate on the histogram for the positive events.
8. Create a statistics view to display the mean fluorescence intensity (MFI) of the gated population.
9. While observing the MFI for the gated population, adjust the laser delay in 0.1- μ s increments within a range of 2.0 μ s of the setting obtained in [step 6](#).

Preserve the setting that maximizes the fluorescence intensity.

10. Reset the **Window Extension** to 10 μ s.
-

Adjusting area scaling

About this topic

This topic describes how to manually adjust the area scaling on your cytometer if necessary for your application. The area scaling is automatically set in CS&T. Depending on the size of your target particle, you might need to adjust the area scaling manually. Larger particles are more likely to require an area scaling adjustment.

About area scaling

The area of a pulse is calculated by BD FACSDiva using measured height and width measurements. It is sometimes important to verify that the area calculation and the height measurement are equivalent by adjusting the factor applied to the area. The required area scaling factor changes based on sheath pressure and particle size.

About this example

The following example describes how to adjust area scaling for an experiment which uses only the 488-nm laser and the 640-nm laser. You must adjust area scaling for all lasers used in your experiment. To adjust the other lasers, add a parameter and the corresponding plots from that laser to the procedure.

Adjusting area scaling

To adjust area scaling:

1. Open an existing experiment, or create a new experiment in the **Browser**.
2. Create a new specimen by clicking the **New Specimen** button on the **Browser** toolbar.

- In the **Inspector**, click the **Parameters** tab and select the **H** checkbox to select height for each parameter.

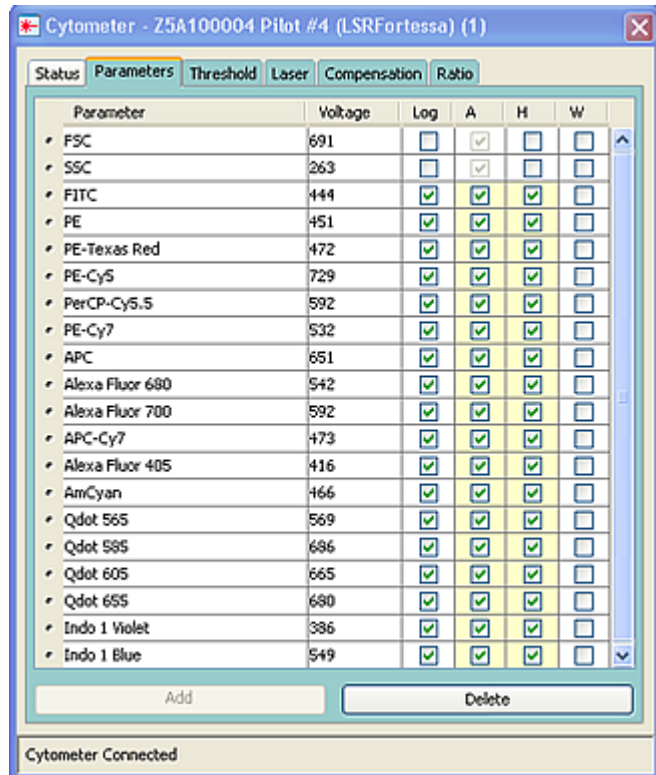

- On the global worksheet, create the following plots and histograms:
 - FSC vs SSC dot plot
 - FSC-H and FSC-A histogram
 - FITC-H and FITC-A histogram
 - APC-H and APC-A histogram
- Create a P1 gate in the FSC vs SSC plot, and show only the P1 population in all histograms.

6. Create three statistic views showing the following:

- FSC-H and FSC-A means for P1
- FITC-H and FITC-A means for P1
- APC-H and APC-A means for P1

Your worksheet should look similar to the following figure.

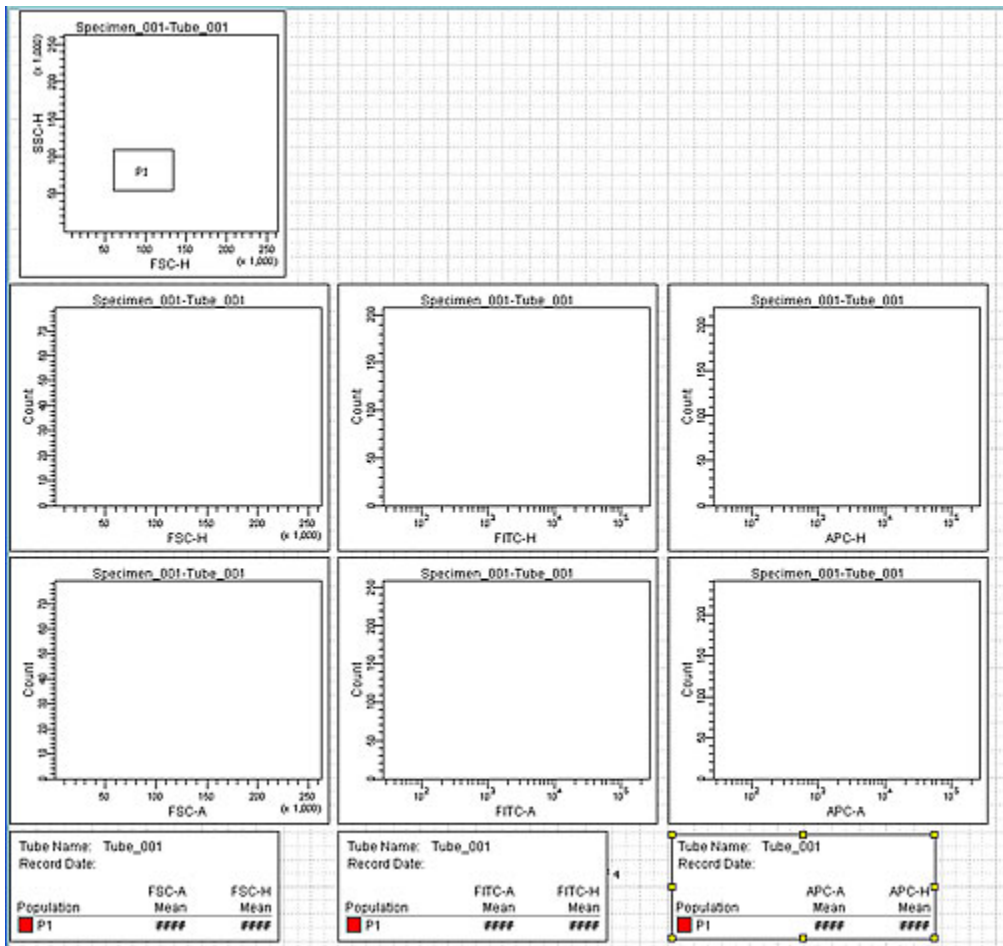

7. Expand the new specimen, then set the current tube pointer to *tube_001*.
8. Install the FITC-positive control tube onto the loading port and click **Load** in the **Acquisition Dashboard**.
9. Adjust the FSC and SSC voltages to place the particles on scale.

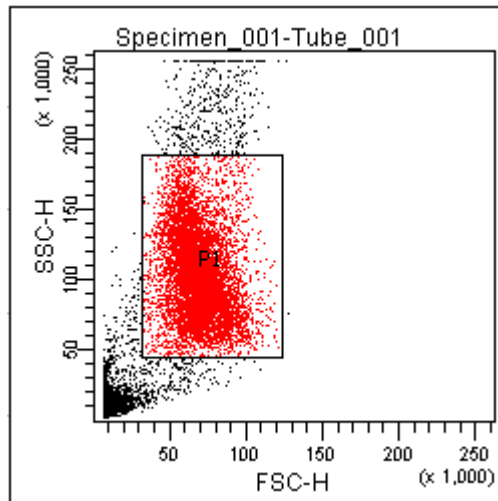

10. Adjust the P1 gate around the population of interest.

11. Adjust the FSC area scaling.
 - a. Click the **Laser Tab** in the **Cytometer** window.

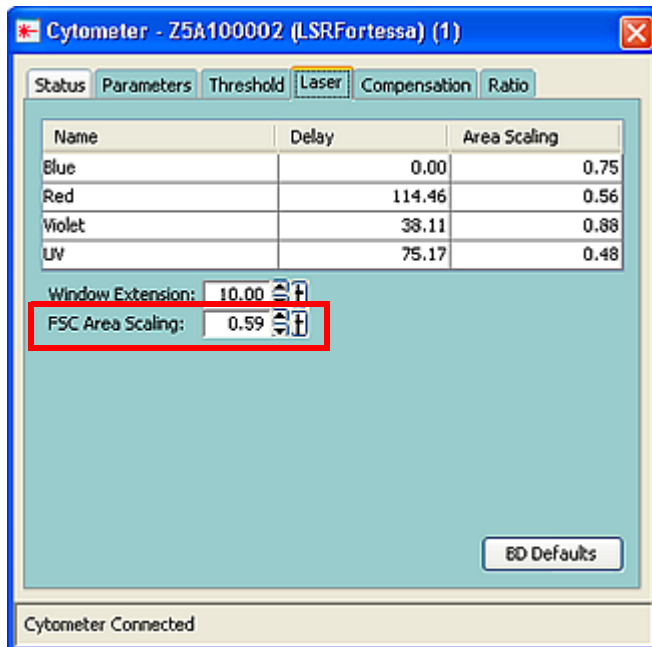

- b. Adjust the FSC area scaling factor until the FSC-A signal matches the FSC-H signal:
 - Increase the area scaling factor if the FSC-A signal is lower than FSC-H.
 - Decrease the area scaling factor if the FSC-A signal is higher than FSC-H.
 - c. View the result of your change in the histograms and statistics views.
12. Adjust the blue laser area scaling factor until the FITC-A signal matches the FITC-H signal, if needed.
13. Unload the FITC-positive control tube, then load the APC-positive control tube.

- Adjust the red laser area scaling factor until the APC-A signal matches the APC-H signal, if needed.

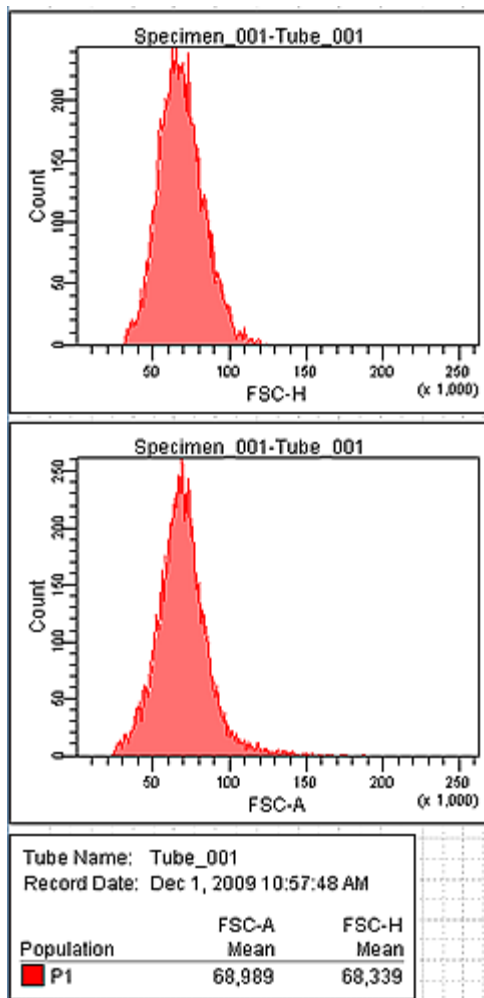

Need more information fast?

Information about this product is also available in your software's Help system.

You can keep the Help window open while you use the software or print the information directly from the window.

Internet access is not required to use the Help system.

11

Supplies and consumables

This chapter covers the following topics:

- [Ordering information \(page 176\)](#)
- [Particles \(page 177\)](#)
- [Reagents \(page 178\)](#)
- [Equipment \(page 179\)](#)

Ordering information

To order spare parts and consumables from BD Biosciences:

- Within the US, call (877) 232-8995.
- Outside the US, contact your local BD Biosciences customer support representative.

Worldwide contact information can be found at bdbiosciences.com.

Particles

About this topic

This topic lists the QC and CS&T particles available.

QC particles

Particle	Laser	Supplier	Catalog No.
SPHERO™ Rainbow Calibration Particles (8 peaks)	All	BD Biosciences	559123
SPHERO Ultra Rainbow Fluorescent Particles (single peak)	All	Spherotech, Inc.	URFP-30-2
DNA QC Particles kit	Blue (488 nm)	BD Biosciences	349523

CS&T particles

Particle	Laser	Supplier	Catalog No.
BD Cytometer Setup and Tracking (CS&T) beads	<ul style="list-style-type: none"> • UV (355 nm and 375 nm) • Violet (405 nm) • Blue (488 nm) • Red (640 nm) • Yellow-green (561 nm) • Green (532 nm) 	BD Biosciences	<ul style="list-style-type: none"> • 641319 (1 vial) • 642412 (3 vials)

Reagents

Reagent	Supplier	Catalog No.
BD FACST TM sheath fluid	BD Biosciences	342003
BD FACS sheath solution with surfactant (recommended for use with the HTS option)	BD Biosciences	336524
Monoclonal antibodies	BD Biosciences	See the BD Biosciences Product Catalog or the BD Biosciences website (bdbiosciences.com)
BD FACS TM lysing solution	BD Biosciences	349202
BD FACSRinse solution	BD Biosciences	340346
BD FACSClean solution	BD Biosciences	340345
Dyes and fluorochromes	BD Biosciences, Molecular Probes, or Sigma	–
Chlorine bleach (5% sodium hypochlorite)	Clorox or other major supplier (to ensure that the bleach is at the correct concentration and free of particulate matter)	–

Equipment

Equipment item	Supplier	Catalog No.
Bal seal	BD Biosciences	343509
O-ring, sample tube		343615
Sheath filter assembly		345743
BD Falcon polystyrene test tubes, 12 x 75-mm		352052 352054 352058

Need more information fast?

Information about this product is also available in your software's Help system.

You can keep the Help window open while you use the software or print the information directly from the window.

Internet access is not required to use the Help system.

Index

Numerics

- 355-nm UV laser 148, 152, 159
- 405-nm violet laser 145–147, 151, 157
- 488-nm blue laser 139–141, 149, 154
- 532-nm green laser 153, 162
- 561-nm yellow-green laser 152, 161
- 640-nm red laser 142–144, 150, 156

A

- acridine orange (AO) 41
- air bubbles, removing 28
- alarm
 - battery test 46
 - waste container 17
- analysis
 - data 82
 - immunophenotyping 88
 - reusing 94
 - saving 94
- antibodies 101
- AO *See* acridine orange
- application settings
 - applying 84
 - creating 73
- area scaling 168
- arm, tube support 15
- aspiration (sample), rapid 117
- assistance, technical 7

B

- Bal seal
 - ordering 179
 - replacing 52
- bandpass (BP) filters
 - detector array placement 20
 - holder 34
 - theory 106
- base configurations 138
- battery
 - changing 47
 - test 46
- BD FACSClean solution 178
- BD FACSDiva software *See* software
- BD FACSFLOW sheath fluid 178
- BD FACSFLOW solution 27
- BD FACSFLOW supply system 24, 43
- BD FACSRinse solution 42
- BD Falcon tubes 179
- BD High Throughput Sampler (HTS) 16
- blank optical holders 35
- bleach 40, 178
- blue 488-nm laser 139–141, 149, 154
- BP *See* bandpass filters
- bubbles, removing air 28
- buttons
 - fluid control 14
 - sample flow rate control 13

C

- calculating compensation 80
- capacity, waste container 17
- cleaning solutions 40
- compensation
 - calculating 80
 - control tubes 76
 - recording settings 77
 - theory 108
- components
 - cytometer *shown* 11
 - sheath container *shown* 26
 - sheath filter *shown* 50
 - waste container *shown* 31
- computer system, about 21
- configuration
 - base 133
 - BD FACSDiva 61
 - maps 132
- containers
 - sheath 17, 26
 - waste 17, 30, 32
- control panel, cytometer 12
- controls
 - fluidics 12
 - single-stained 60, 82
- conventions
 - keyboard 4
 - safety symbols 3
 - text 4
- creating
 - analysis objects 88
 - global worksheets 83
 - statistics view 88
- CS&T particles 177
- cuvette flow cell 164
- CV, troubleshooting 125
- cytometer 10
 - components *shown* 11
 - configuration 35, 61

- disconnect error 127
- door and drawer 36
 - setup 58
 - starting 24
- troubleshooting 116

D

- DAPI, cleaning after using 41
- data
 - analyzing 82, 88
 - gating 88
 - recording 82, 85
- debris, excessive 124
- default configuration 133
- delay, laser 164
- detector arrays 18
- detectors 20
- dichroic mirrors
 - slots 34
 - theory 107
- digital data 10
- digital electronics 113
- Diva software *See* software
- DNA, flow rate for analysis 99
- droplet containment system 16

E

- electronics
 - digital 113
 - laser controls 114
 - pulse 111
 - pulse measurements 112
 - threshold 113
 - troubleshooting 127
- emission duration 111
- event rate
 - erratic 123
 - high 121
 - low 122

- zero 117, 119
- excessive debris 124
- excitation wavelength 101
- experiments
 - creating 69
 - immunophenotyping 83
 - sample optimization 69
 - specifying parameters 70

F

- FACSFlow sheath fluid 178
- FACSFlow solution 27
- Falcon tubes 117, 179
- filters, optical
 - bandpass (BP) 20, 106
 - changing 36
 - dichroic *See* dichroic mirrors
 - longpass (LP) 103, 104
 - notch 104, 155
 - shortpass (SP) 103, 105
 - slots 34
 - theory 103
- filters, sheath
 - attaching new 51
 - replacing 50
- FITC and Stokes shift 101
- fixed-alignment lasers 10
- flow cell
 - draining 33
 - fluidics 98
- flow rate control buttons 13
- fluid control buttons
 - PRIME 14
 - RUN 14
 - STNDBY 14
- fluidics
 - description 13, 98
 - flow rate control 13
 - flushing system 44
 - priming 33

- removing air bubbles 28
- run mode 14
- sample injection port (SIP) 15
- fluidics controls, cytometer 12
- fluidics interconnect 29
- fluorescence
 - defined 101
 - emission 111
- fluorescence signal, none 120
- fluorochromes
 - compensation theory 108
 - emission spectra 102
 - measured 35
 - role in light emission 101
- flushing the system 44
- forward scatter (FSC) 100
- FSC *See* forward scatter

G

- gating data 88
- global worksheets
 - analyzing data 88
 - creating 83
 - previewing data 82, 94
- green 532-nm laser 153, 162

H

- hazard symbol definitions 3
- Help, accessing 5
- High Throughput Sampler (HTS) 16
- hydrodynamic focusing 98

I

- immunophenotyping
 - analysis 88
 - experiment 83
 - hydrodynamic focusing 99

K

keyboard conventions 4
 knob, SAMPLE FINE ADJ 13

L

laser delay
 about 164
 optimizing 165
 lasers
 options 19
 performance check 64
 quality control (QC) particles 177
 longpass (LP) filters
 defined 103
 holder 34
 theory 104
 LP *See* longpass filters

M

maintenance
 Bal seal 52
 battery change 47
 battery test 46
 cytometer shutdown 43
 sample tube O-ring 54
 schedule 41
 scheduled 44
 sheath filter 50
 system flush 44
 waste management system 46
 mirrors, dichroic longpass (LP) filter 20

N

notch filters 104, 155

O

octagon
 configuration maps 132

 detector 10
 location 36
 shown 20
 online Help 5
 optic holder 35
 optics
 components 18
 configuration 61, 62
 dichroic mirrors 107
 filters 19, 36, 103
 location 11
 optimization, sample 58
 ordering spare parts 176
 O-ring
 ordering 179
 replacing 54
 worn 116

P

particles 177
 PerCP, Stokes shift 101
 performance check 64, 65
 photodiode 20
 photomultiplier tubes (PMTs) 20
 PMT *See* photomultiplier tubes
 population hierarchy 88
 power switch 11, 12
 PRIME, fluid control button 14
 priming fluidics system 33
 propidium iodide (PI) 41
 pulse
 definition 111
 measurements 112
 processors 112

Q

quality control (QC)
 particles 177
 troubleshooting 125

R

- recording
 - compensation settings 77
 - compensation tubes 76
 - data 82, 85
- red 640-nm laser 142–144, 150, 156
- removing air bubbles, filter 28
- replacing
 - Bal seal 52
 - battery 47
 - optical filters 36
 - sample tube O-ring 54
 - sheath filter 50
 - waste air filter 49
- reusing analyses 94
- rinsing solution 42
- RUN
 - button orange 119
 - fluid control button 14

S

- safety symbols 3
- sample
 - optimization 58
 - optimization experiment 69
 - optimization, single-stained controls 60, 82
- SAMPLE FINE ADJ knob 13
- sample injection port (SIP)
 - components 15
 - hydrodynamic focusing 98
 - location 11
 - replacing Bal seal 52
 - replacing sample tube O-ring 54
- sample tube
 - injection 15
 - not fitting 117
 - requirements 117
- samples, running 85

- saving analyses 94
- scatter
 - light 100
 - parameter distortion 123
- setup, cytometer 58
- sheath
 - flow 98
 - pressure 98
- sheath container
 - components *shown* 26
 - defined 17
 - depressurize 27
 - preparing 27
- sheath filter
 - components *shown* 50
 - ordering 179
 - removing air bubbles 28
 - replacing 50
- sheath fluid 98
 - backflush 16
 - BD FACSFLOW sheath fluid 178
- shortpass (SP) filters 103, 105
- side scatter (SSC) 100
- signals, amplifying 20
- SIP *See* sample injection port
- software
 - cytometer control 2
 - version 21
- spare parts, ordering 176
- spillover 108
- SSC *See* side scatter
- starting cytometer 24
- statistics views 88
- STNDBY, fluid control button 14
- Stokes shift 101
- support, technical 7

T

- technical assistance 7
- testing battery 46

- text conventions 4
- thiazole orange (TO) 41
- threshold, defined 113
- TO *See* thiazole orange
- trigon
 - configuration maps 132
 - detector 10
 - location 36
- troubleshooting
 - cytometer 116
 - electronics 127
- tubes
 - Falcon 117, 179
 - requirements 117

U

- user preferences 62
- UV 355-nm laser 148, 152, 159

V

- violet 405-nm laser 145–147, 151, 157

W

- waste air filter
 - component *shown* 31
 - replacing 49
- waste air vent filter
 - replacing 119
- waste container 17
 - alarm 17
 - battery test 46
 - capacity 17
 - components *shown* 31
 - defined 17
 - emptying 30
 - pressurized 32, 119
 - replacing battery 47
- window extension 166
- workstation, about 21

Y

- yellow-green 561-nm laser 152, 161